



Technical Instructions
BM Wheel Balancers – new generation from Oct 2010

Status: 27. August 2013

Content:

1. Recommended spare parts list..... 4

2. General information on servicing machines..... 4

3. Drive belt 5

4. Main switch 6

5. Motor 8

6. Piezo sensors 9

7. Opto encoder-printed circuit board..... 10

8. Motor control board..... 11

9. Basic board..... 13

10. Drive belt pulley 16

11. Wheel guard micro switch..... 17

12. Potentiometers 18

13. Software update basic board 21

14. Software update Touch PC..... 25

15. Service Functions 26

16. Mid centring device (NOT QuickSpan) 34

17. QuickSpan 35

18. Foot pedal (QuickSpan)..... 36

19. Maintenance unit (QuickSpan)..... 37

20. Repair Instructions for clamping fingers (QuickSpan)..... 38

21. Using UNI-LUG and Motorcycle adaptor on QuickSpan..... 41

22. Trouble shooting and problem solving 47

23. Electrical schematic layout 51

24. Dimensions 53

25. Technical data 54

1. Recommended spare parts list

A suggested list of spare parts is recommended to be kept at the customer's location in order to rectify problems that might occur more quickly. A list below is also provided on our home page.

1987009WH7A	POTENTIOMETER Distance + Diameter with cable
1987009WH9A	POTENTIOMETER with cable for outside gauge
1987009WH4A	Wheel guard switch
1987009WN3A	FORK LIGHT SENSOR with cable
1987009WH2A	TRANSDUCER SENSOR complete with cable
1987009WB7A	MOTOR with brake
1987009WB5A	MOTOR without brake for BM 11, 15 Touch, QuickSpan champ
1987009WD3A	PRINTED-BOARD ASSEMBLY for BM 30-2, BM 40-2, QuickSpan comfort, QuickSpan chrome
1987009WD3A	PRINTED-BOARD ASSEMBLY for BM 11, QuickSpan champ
1987009WD2A	PRINTED-BOARD ASSEMBLY for Touch PC
1987009WA7A	Motor control unit complete for BM 11, 15 Touch
1987009WA8A	Motor control unit complete for BM 30-2, 40-2, 35 Touch, 45 Touch, all QuickSpan models
1987009W8MA	Mid centering device QuickSpan complete
1987009W8LA	Repair kit QuickSpan „Fingers“
1987009W8NA	Repair kit pneumatic cylinder QuickSpan

2. General information on servicing machines

a) Repairs and servicing should only be carried out by qualified personnel.

b) Safety procedures:

Before opening the cover to the electronic parts switch off the main switch and remove the electrical plug. Take special care not to touch the heat sink on the power control board of the monitor machine versions because this holds a constant voltage of 230V, or 110V when the machine is connected to the mains!

Never leave a machine unguarded, which has open electric parts!

Before a machine is brought back into operation after repairs, ensure that no tools or components are in contact with the rotating parts of the main shaft.

c) Make sure that a zero run and a calibration has been carried out every time after the machine has been serviced or adjustments have been made to internal components!

d) Should components fitted to other parts e.g. the electronic boards become defective, do not try to replace these yourself (except for fuses). If the machine is still in under warranty, the complete board should be changed. A loss of warranty will occur if any alterations are made to individual components!

e) Use only original parts to avoid the problems arising from using parts not having the correct technical specifications or which have no guarantee for this machine. Corresponding spare parts can be found in the spare parts document as well as finding it on our home page.

3. Drive belt

a) In order to replace the drive belt, loosen four bolts (1- 4). Next, loosen the tension bolt (5) to allow the motor to pivot towards the belt pulley. Take off the belt. Replace with a new belt being careful to make sure that the belt is as close as possible to the main shaft assembly to allow it to fit correctly onto the small drive pulley. Tighten the tension bolt (5) and then the four mounting bolts (1-4). Make sure that the tension on the belt is sufficient to allow 1cm

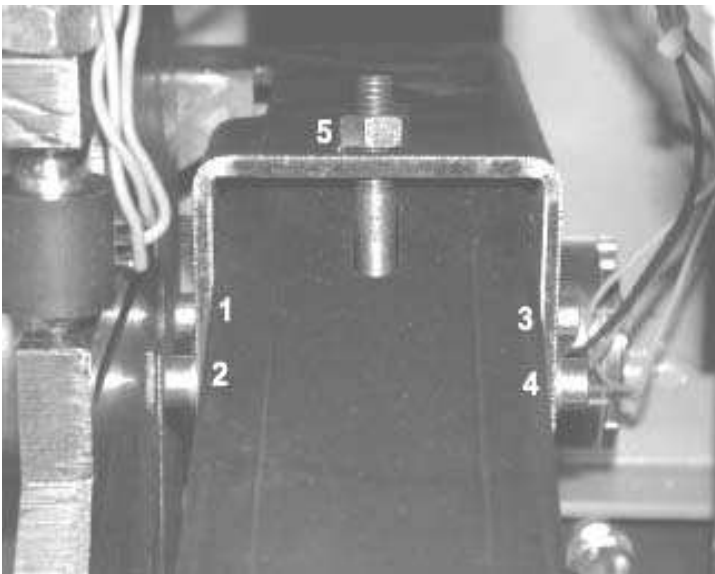

b) The direction arrows on the drive belt have no role to play because the rotation of 150 rpm for the main shaft is very low. Direction arrows can be ignored.
(Drive belt, Art.Nr. 1987009WK1A)

c) Noises coming from the belt do not affect the results on the machine. Do not use grease or oils to lubricate otherwise the loss of friction on the pulley could alter the rotational speed of the main shaft.



4. Main switch

a) The main switch can be found on the left side of all machines. It can also be used as an emergency off switch. Before any repairs are carried out to the machine please do not forget to: **DISCONNECT MAINS PLUG!**



b) In order to remove the main switch, loosen the small screw as seen in the picture and pull on the lever.



From the outside you will now see four screws on the cabinet wall, which secures the main body of the switch. Loosen these screws to remove the element.



The next picture shows the inside of the cabinet with the main body and two of the four screws. On the main body are four electrical connections numbered 1-4 which are the in and out going power lines to the main switch.



Contact 1 is the outer conductor and contact 3 is the Neutral wire which is connected to an earth plug. Contact 2 is the inner conductor and is protected by fuse X1-F1. Contact 4 connects to the neutral connection X1. (If in doubt, please check wiring diagram)

5. Motor

a) Disconnect the red and black motor cable at the point (J2-2, J2-3). In addition if the machine is a model (above BM30) also disconnect the two grey brake leads at the point (J4-2, X1-3).

b) Loosen the drive belt as described in Para. 5. Loosen the securing screws(1)

(4) to remove the motor. Place new motor in position and tighten the screws (1)-(4).

Replace the drive belt as described above and replace the electrical cables.



c) Note: When ordering new motors make sure that the correct motor for the specific kind of machine is chosen.

DC motor (24V) without braking capability for BM11, BM 15 Touch and QuickSpan champ and a DC motor (48V) with braking capabilities for all from BM 30 upwards.



Photo. Shows motor without brakes
Art.Nr. 1987009WB5A

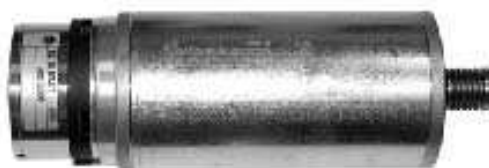

Photo. Shows motor with brakes
Art.Nr. 1987009WB7A

6. Piezo sensors

a) Disconnect the connecting lead J6 from the Basis board. Loosen the piezo sensor securing nut (1) and screw out the securing bolt (2) using an Allen key. Please note that on machines built from August 2011 the screw of the sensor is secured inside the thread with Loctite

Look out for the four ball bearings (3) at either end of the piezo sensors. To replace the sensors, first clean and then put a small dab of grease into the socket spaces for the ball bearings, clean the thread from remaining Loctite, put medium type Loctite on the screw and place the Piezo sensor gently into position.

Return each piezo sensor with the ball into position and screw on the sensor securing bolt making sure that the ball is also in position. Tighten the securing bolt to **2Nm**. Do not over tighten the sensors and tighten the securing bolts alternately.

Replace the securing nut and finally re-connect the leads to the basis board at the point J6.

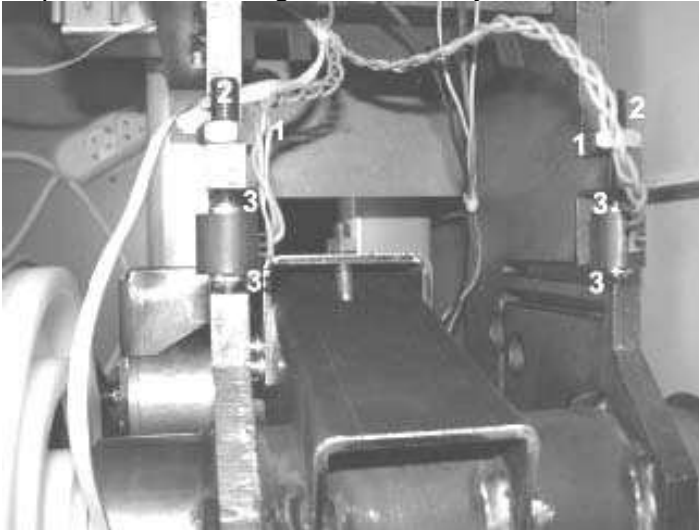

b) The piezo sensors always come as a set with balls and a single shared lead connecting to a plug. They can be fitted in any position i.e. front, rear, left or right without any adverse affects on results. After replacing the sensors, it is imperative that a zero run and calibration are carried out.

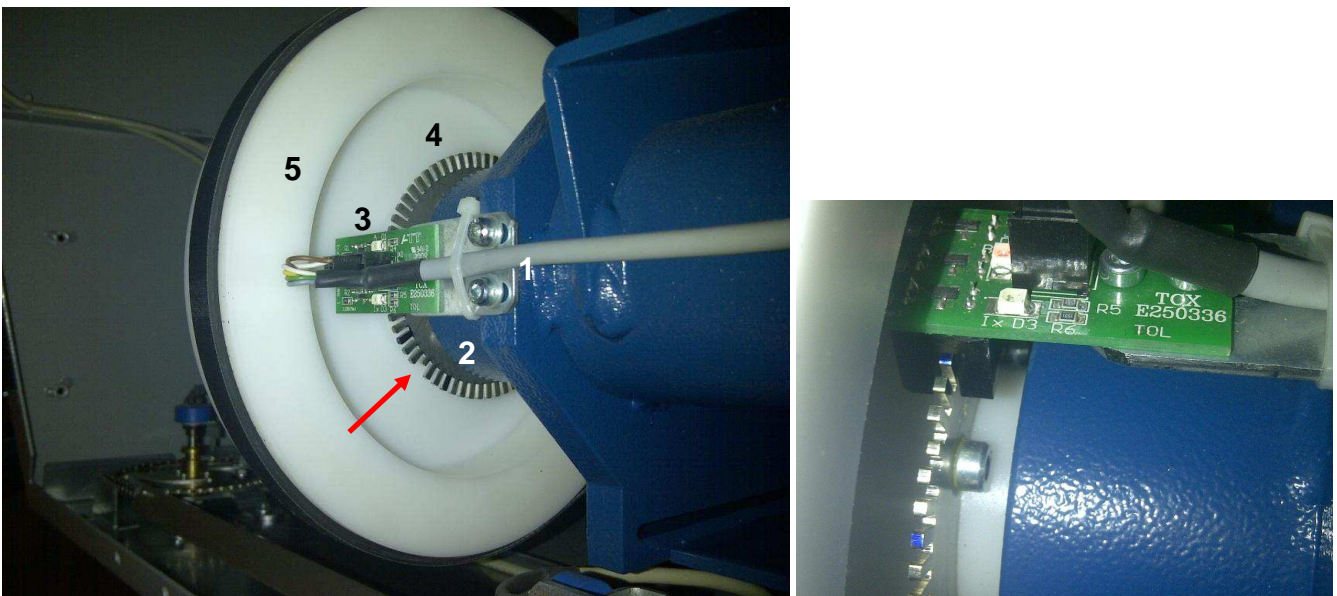

Photo shows Piezo sensors (Art.Nr. 1987009WH2A)

7. Opto encoder-printed circuit board

a) There are three red light diodes on the opto encoder printed circuit board. When these three light diodes are blinking during the operation of the machine, it means the opto encoder is functioning. If the machine is switched on (CAREFUL VOLTAGE) and the main shaft is turned slowly, the blinking of the diodes can be observed.

b) To remove, unplug the lead at J2 on the basis board. Loosen the securing screws (1) enabling the metal support (2) with the opto encoder board to be withdrawn from the machine. Unscrew the opto encoder board (3) from metal support and replace with another. Return metal support with opto encoder into position and secure. The opto encoder board must not make any contact with either the toothed disc (4) or the drive pulley (5). Finally re-connect the plug



c) Note: If a new opto encoder board has been fitted and the position for placing weights cannot be found, then the actual angle of the opto encoder in relation to the toothed disc should be checked. As seen in the upper picture, the sensor should be at 90° to the drive pulley

d) If you check the toothed disc, you will find a position where there is a small gap (See red arrow in the picture above). This position is measured by the opto encoder as Zero point. The toothed disc has 256 segments and by selecting function F9 on an LED machine you can see the number of each segment as the main shaft is turned. With monitor machines, the same function can be checked in the service screen reading from the bottom left of the screen. If the main shaft is turned a complete revolution in a clock wise direction the scale will count from 0 to 255 and likewise opposite in a counter clockwise direction.

8. Motor control board

a) The motor controller board works in conjunction with the transformers (located on the lower side of the board to make up the power supply for the balance machine. To remove the motor controller board, unplug the connected cables and loosen the securing screws. Replace a new board opposite to the method of removing.

b) Overview of the symbols printed next to the relevant connections:

- J3 Control line basis board -> Motor controller board
- J5 Bridge 115 V / 230 V input voltage
- J6 Power supply to the basis board
- X5 Mains supply
- X4 Connection to primary side of transformer (located below motor control board)
- X5 QuickSpan
- X6 Connection to secondary side of transformer (located below motor control board)
- X7 Motor and Brake

c) The red LED D1 indicates whether 24VDC or 48VDC is available. The LED will stay illuminated even when the machine has been unplugged from the mains because the power supply unit contains a filter capacitor. The light can also illuminate when the motor is turned as it acts like a generator and so charges the capacitor with electricity simultaneously.

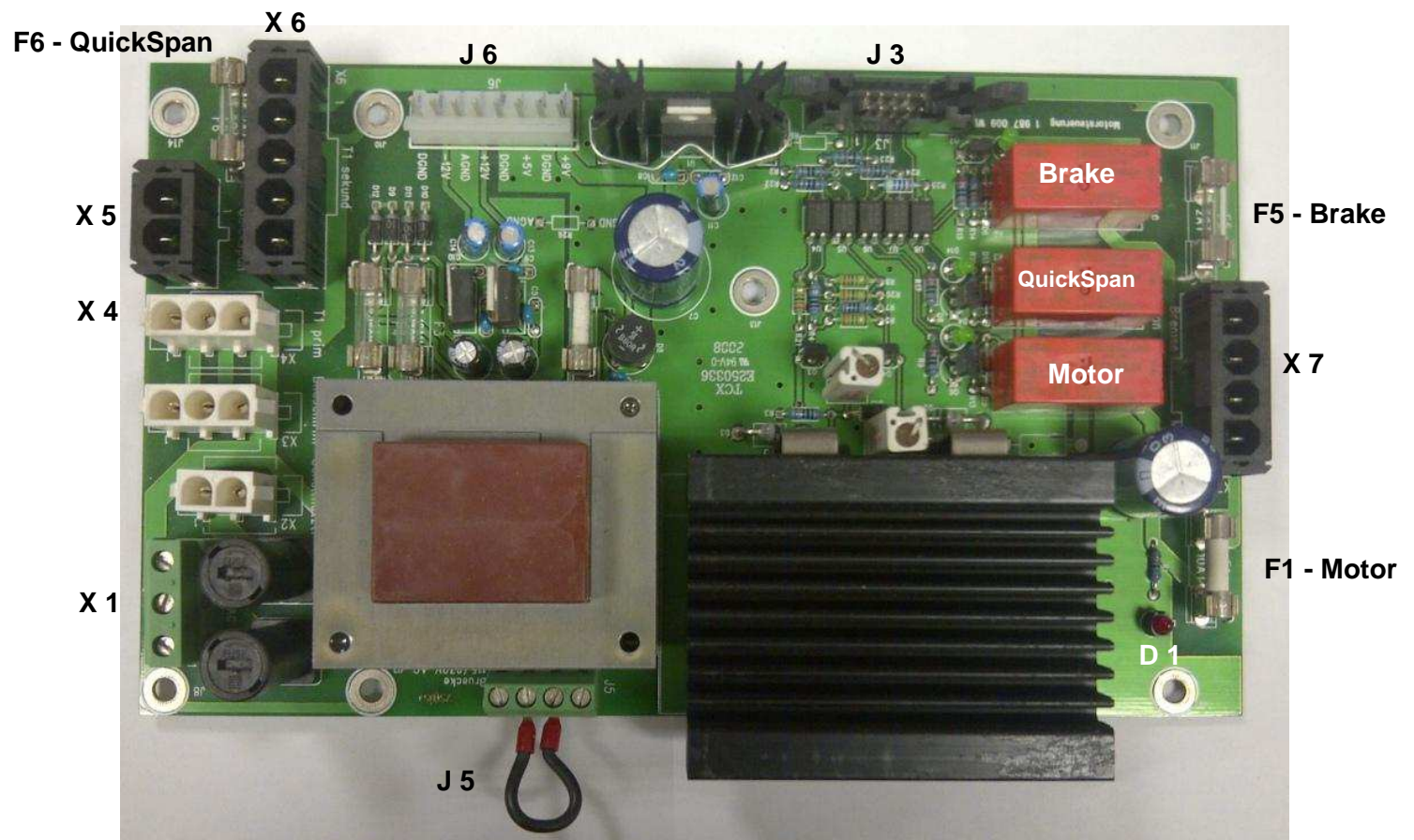

More information on fuses see chapter 22

Motor control board lower side

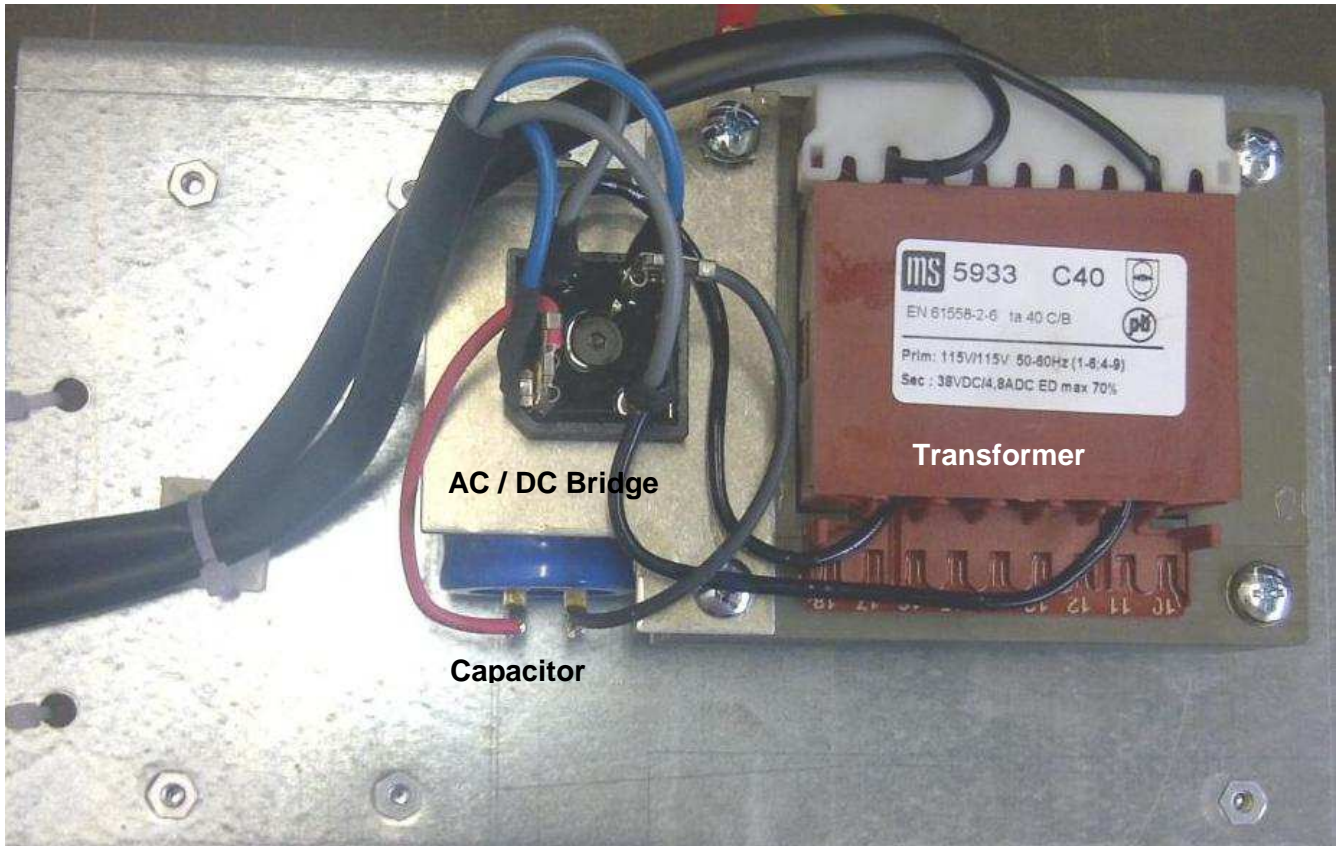

9. Basic board

- a) The basic board evaluates and saves all the measurement values and software as well as controlling the standard electronics. Light diodes can be found on the underside side of the board, which provides the display for the LED machines. The board is secured to an aluminium plate on one side and a keypad on the other. On the monitor machine, the basic board is located on the rear wall of the cabinet to the right side of the PC printed board assembly.
- b) To exchange, unplug all leads, remove the board and replace returning the leads to the same positions.
- c) After exchanging a basic board, all measurement values data is lost and so it is important that a zero run and calibration are carried out.

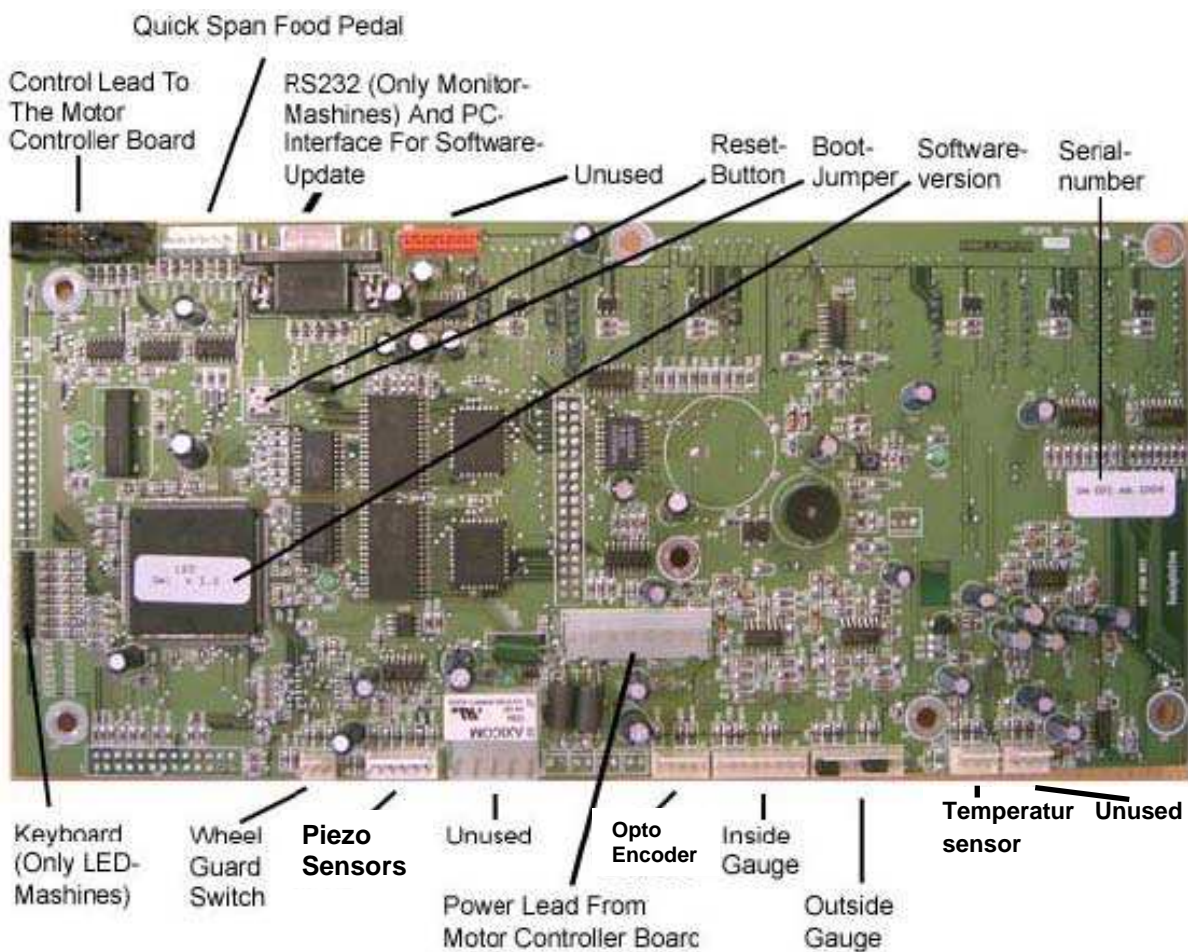

Generally, the basic board is already flashed with the most up to date software before leaving the factory, which is why it is very important to note the type and serial number of the machine before ordering a new board.

- d) There are two jumpers plugged into the pins of the connector J12 for the outside gauge as seen in the photo above, displaying the positions (1-2 and 5-6) they should be in on all machines except BM 40-2, BM 45 Touch and QuickSpan chrome. From BM40-2 upwards this plug is used for the outside arm and so the jumpers would have to be removed!

e) The list below shows a summary of all the connectors on the basis board with their codes which are marked next to each connector on the board.

- J1 Key pad (only LED-machines)
- J2 Piezo-sensors
- J3 unused
- J4 unused
- J5 Wheel guard micro switch
- J6 Opto encoder printed circuit board
- J7 unused
- J8 Potentiometer for Distance and Diameter
- J9 Main power supply coming from Motor controller board.
- J10 unused
- J11 Temperature sensor
- J12 Potentiometer 3 outside arm (from BM40)
- J13 Boot-Jumper for Service update of the Software
- J32 Foot pedal switch (QuickSpan)

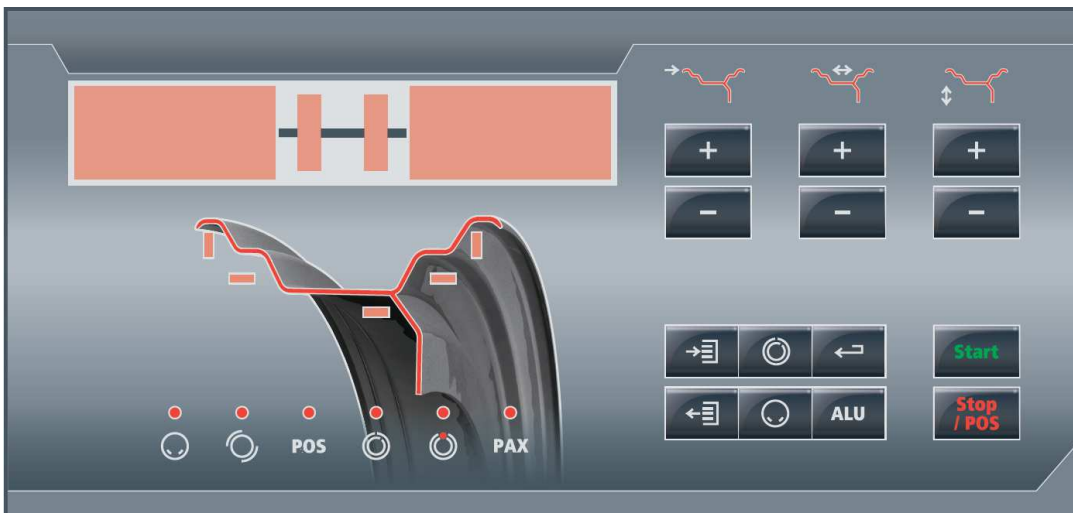

f) When removing the basis board from the aluminium plate, please be careful not to bend the ribbon cable as it can be easily damaged and cause the machine to function improperly.

On the Touch PC machines the basic board (1) is located inside the machine and mounted on a panel together with the power pack (2) for the Touch PC



10. Drive belt pulley

b) To exchange the belt pulley, take off the drive belt and then the screw (3) to enable the pulley to be taken off the main shaft.

When removing the pulley be careful not to lose the small groove spacer. On fitting a pulley this small groove spacer has to fit into the groove in the centre of the pulley.

The bolt (3) should then be tightened to **exactly 9Nm** using a torque wrench. Loctite (medium type) should also be used to secure the bolt by applying it to the complete length of the threads.

Finally check that the Calibration point (indicator) on the main shaft is in line with the index.

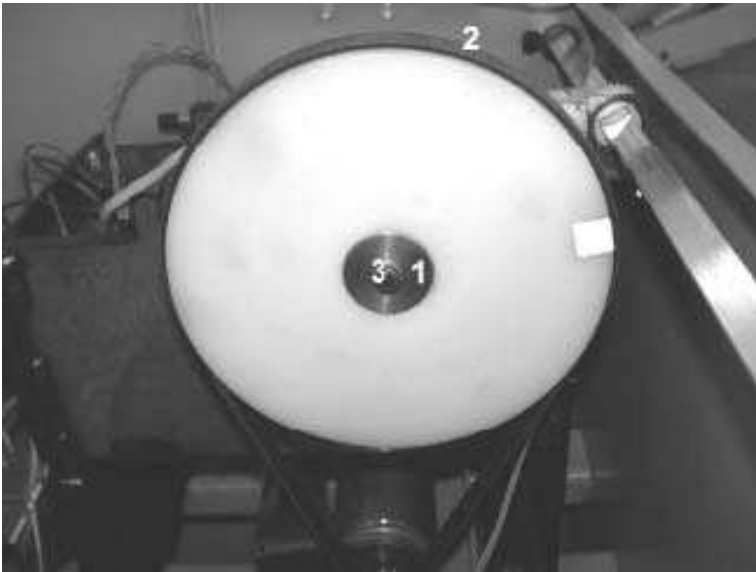

11. Wheel guard micro switch

a) The micro switch relays the position of the wheel guard. Because this process is controlled by the software, it can be switched off. In this case, any problems arising should first be checked by noting the functions set by the user with function F8.!

b) To remove, first take out the lead from the connector J5 on the basic board. Loosen the screws on the switch and remove. Replace the new switch with the wheel guard in an upright position enabling the contacts J5-1 and J5-3 to be connected and in the same case contacts J5-2 and J5-3 to be connected with the wheel guard closed.



(Wheel guard micro switch Art.Nr. 1987009WH4A)

c) If the case arises during transport that the camshaft becomes loose as in the photo below, then re-secure the spring clip by closing the wheel guard so as to align the camshaft with the wheel guard.

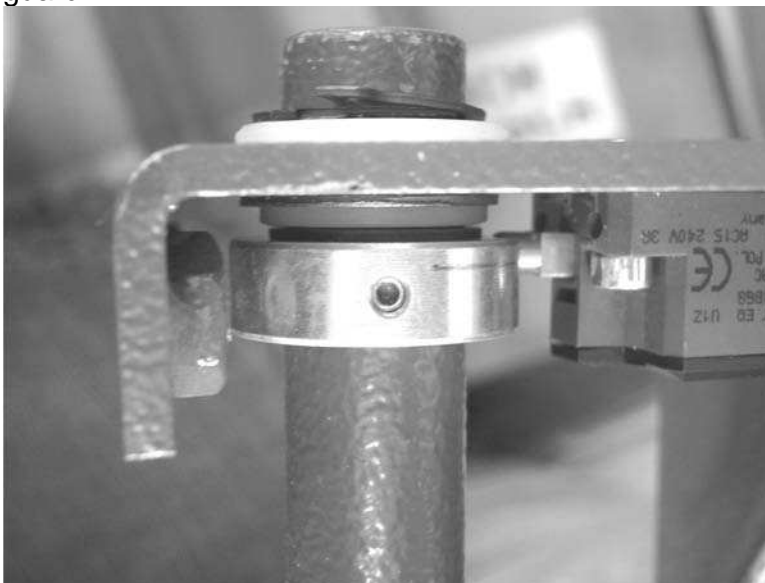

12. Potentiometers

a) Up to three potentiometers can be fitted, depending upon the type of machine.

P1 is the potentiometer at the centre of a chain pulley to measure the distance from the edge of the machine to the first weight position and depending on the type of program selected, the second weight position. The potentiometers have a value of 10kOhm/20%/340°.

b) The potentiometers have an internal mechanical stop position, which is important to note when fitting them to the relevant gauge. The movement of the gauge should not be greater than the stop position otherwise it could damage the potentiometer. The distance potentiometer is connected to J8-1 to J8-4. In order to remove it, the complete chain pulley and chain should be removed by loosening the screws securing it to the cabinet wall. When replacing a potentiometer into the chain pulley, make sure that the potentiometer spindle is turned anti clockwise to almost the position stop. Thereby, when the chain pulley is fitted together with the potentiometer, they will be able to both turn clockwise to the chain pulley position stop

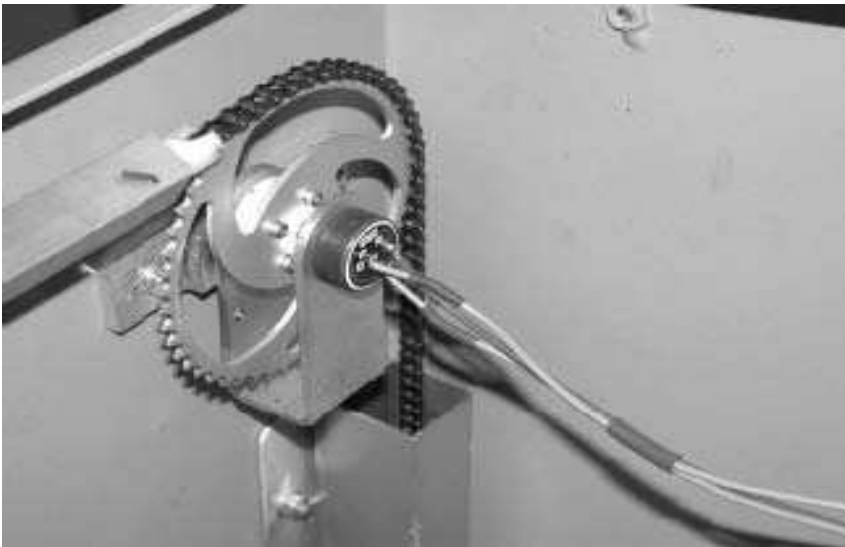

The contact no. 1 on the potentiometer take the white coloured wire and no. 2 the green wire, with no. 3 taking the brown wire.

Contact colour 1 ws 2 gn 3 bn

c) Note: Make sure that while fitting the chain, the gauge is in the home position and the chain pulley is at the stop position shown by the screwed bolt on the pulley contacting a limit stop. The potentiometer spindle should also be shortly before the left hand mechanical stop position.

d) The potentiometer measuring the diameter gauge is connected from points J85 to J8-8. When exchanging please make sure that the potentiometer is turned anticlockwise before fitting. Important: the end of the gauge should be resting on the top of the main shaft housing during replacement to allow minimum and maximum measurements to take place for all types of wheel

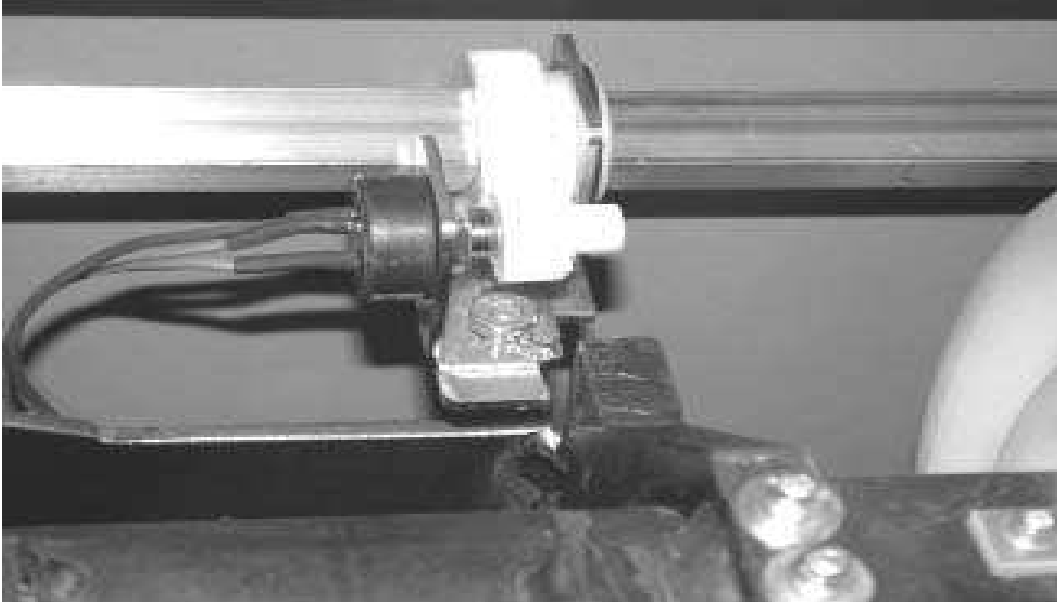

The contact no. 1 on the potentiometer take the white coloured wire and no. 2 the green wire, with no. 3 taking the brown wire.
Contact Colour 1 ws 2 gn 3 bn

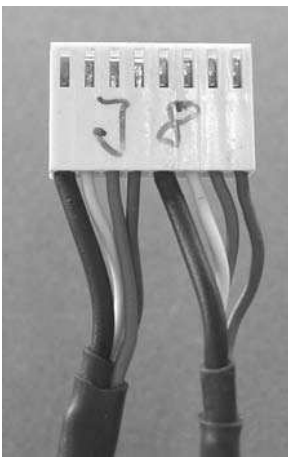

The photo shows connection plug J8. Connected to it are the leads from Potentiometer P1 for the distance gauge (right side) and P2 for the wheel diameter (left side from BM 20 upwards) The colour code order of wires on P2 is black, white, green and brown. For P1 on the other side is also black, white, green and brown.

e) The potentiometer for the width (outside arm) is connected to J12-1 to J12-4. In order to exchange the potentiometer these wires should be soldered onto the new one. The contact no. 1 on the potentiometer take the white coloured wire and no. 2 the green wire, with no. 3 taking the brown wire.

Contact Colour 1 ws 2 gn 3 bn

The reason why the wires need to be soldered is that the plug for the basic board cannot be passed through the tube of the wheel guard and so it has to be removed.

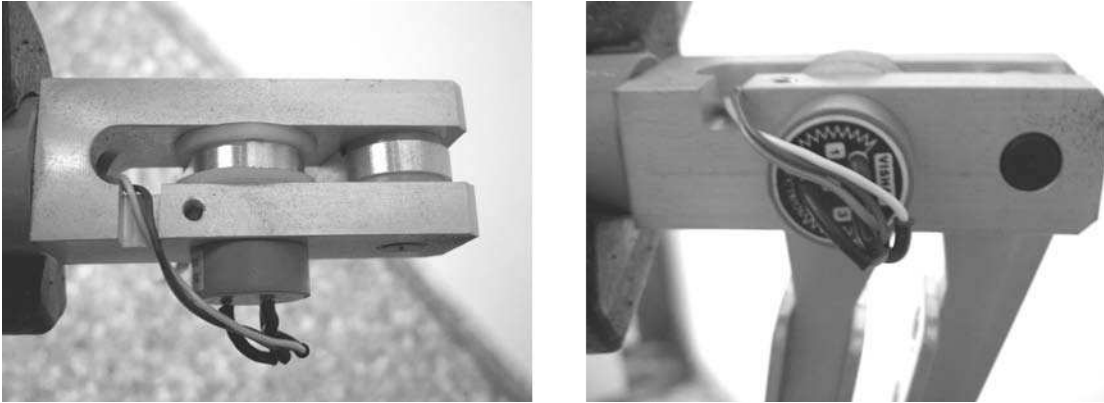

The photos show the position of the potentiometers for the outside arm

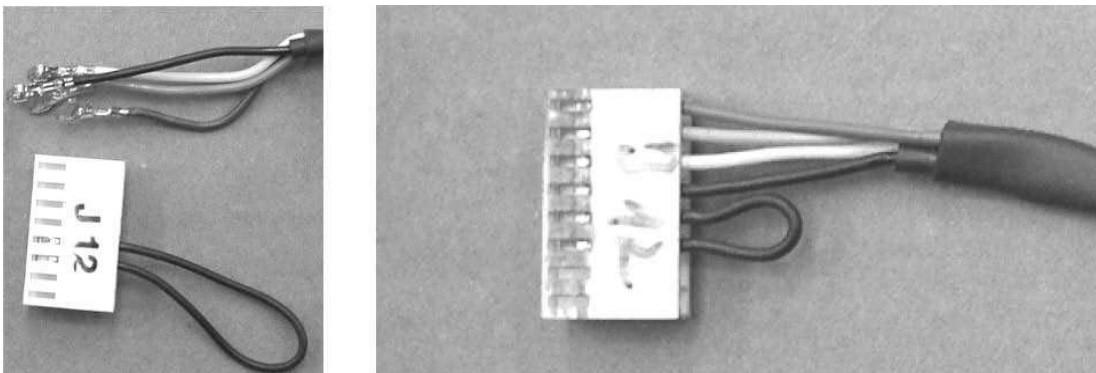

The left photo shows the plug J12, which takes the leads coming from the outside gauge. On the right shows the leads, soldered onto the plug in the order brown, green white and black.

13. Software update basic board

a. General:

The software concept is based on using Flash ROM memories, which allows the machine to start quickly after the operator turns on the main switch. To install the software on the flash memory (flash) you need an application which includes the complete flash process. This makes sure that the software transfers quickly and safely and to the hardware destination remains there. Additionally this application makes it possible, to install new software functionalities on the current machine at any time, without exchanging any tool.

The software as well as the flash tool can be downloaded from the exclusive area (Infocenter) on www.nussbaum-group.de

CAUTION:

Make sure that the software for the Touch PC is always updated FIRST (see chapter 14)

b. System requirements:

System software: Windows XP or Windows 7

- Memory required: 1MB main board memory; max. 0,6MB RAM
- Resolution: minimum of 800x600 pixel Equipment
- The PC / Laptop needs a serial interface (RS232)

c. Start the program:

The program „Flash tool Vxxx.exe“ (xxx is for the version number of the flash tool) should be copied from the CD on your PC/laptop before you start the program. It starts with a double click on the program symbol.

Comment: If the program starts with the CD, the trails and data name of the data file who has to be flashed will not be saved. You have to re-select it after every start of the program.

d. Screen layout:

- 1 Program-title bar for instance with the name of the program and version
- 2 Product selection: Here you select the product on which you want to actualise the software
- 3 Selection of application: Shows the trails and names of the data that has been selected and transmitted by flashing procedure. The last 5 selected data's are available.
- 4 Deletes the flash memory, means prepares the software to install
- 5 Cancelled the flash procedure
- 6 Is to select the interface for which should be flashed
- 7 Here you select the Baudrate (speed) for the data transfer
- 8 Here you can select the data who has to be flashed
- 9 Starts the standard flash procedure with the under 3 or 8 selected data
- 10 View window: Shows all necessary information
- 11 The progress display shows the current situation of the selected functions (delete/flash)
- 12 Select the language

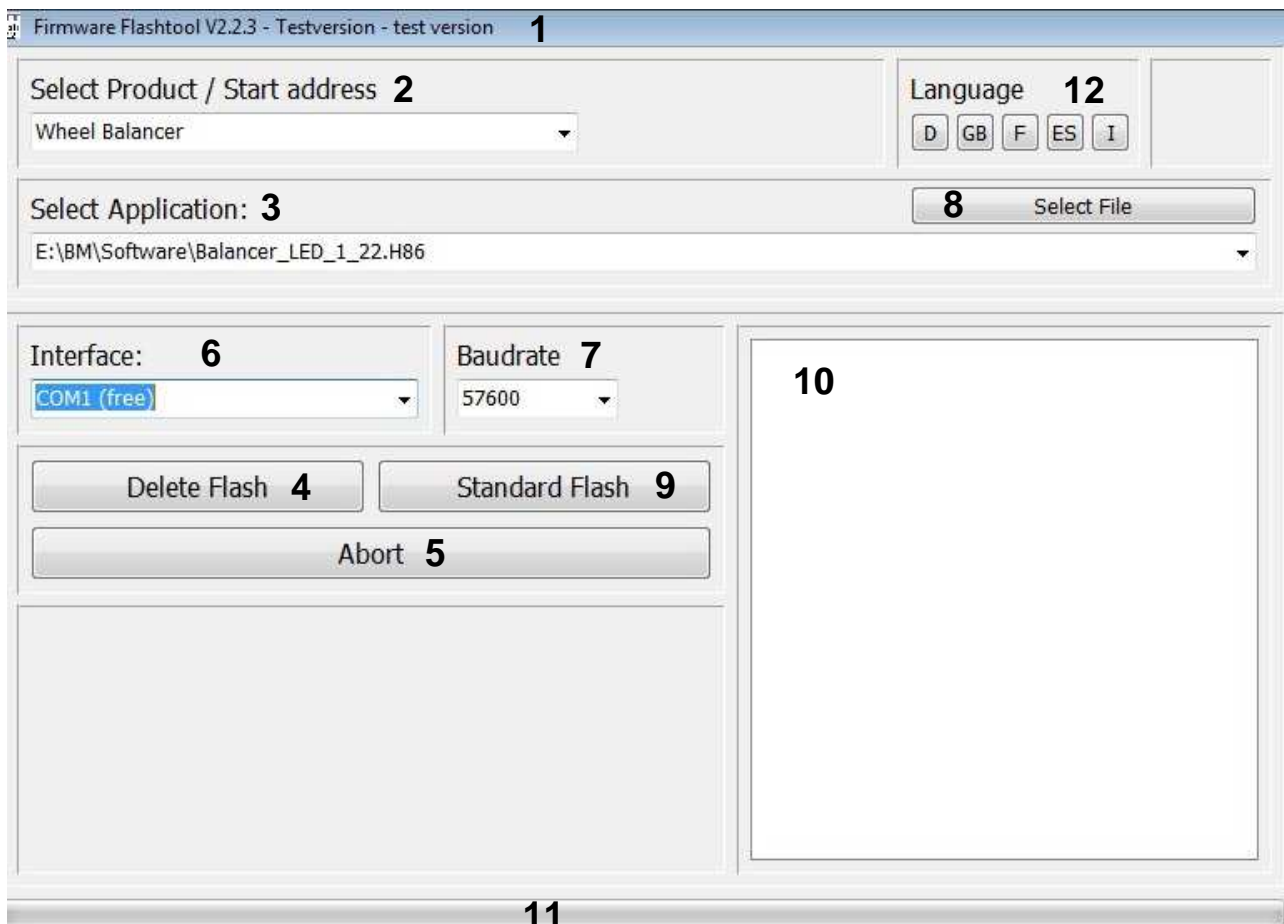

Picture 1: The standard version of the flash tools

e. Description of the flash function:

Preparation basic board:

1. Shut down the machine
2. The jumper on the basic board on which the new software must be installed has to be switched.

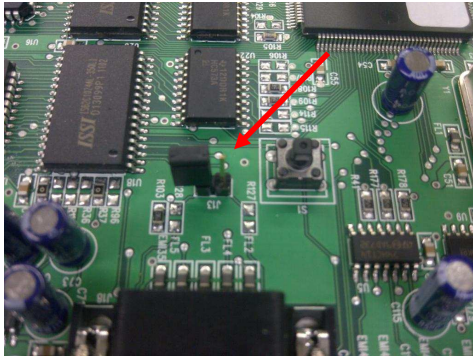

Picture 1:
Jumper open for standard operation

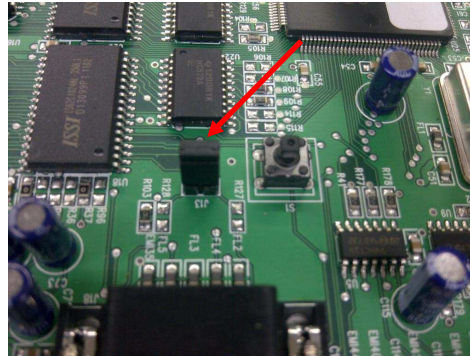

Picture 2
Jumper closed for Flash operation

Comment: on wheel balancers without monitor, the basic board is below the keyboard.

3. The basic board who has to be flashed must be connected with a customary serial cable (Sib D9pins, 1 x plug in, 1 x connector) and a serial interface (see picture 3) on the computer on which the flash tool is. Hereby it concerns about following description:

f. Preparing of flash tool

Start of flash tool:

The flash tool starts by a double click on „Flashtool_Vxxx.exe“. On the screen appears a start window of the flash tool (picture 1 or picture 2)

Select the serial interface, on which you connected the serial cable. The serial interface „COM 1“ which is already pre-adjust should be correct, in other case with several serial interfaces please select the highest or furthest on the left presented interface (see on the back side of the computer). Otherwise select „COM 2“, „COM 3“ or „COM 4“

Select WHEEL BALANCER with „select product / start address“, if it is not already selected.

Select under "select application" your file or press the button " select file " and select the catalogue with the file that has to be flashed.

Such a file is named "Balancer_LED_1_22.H86" or "Balancer_Touch_1_22.H86".

After you selected the file and with the button "open" confirmed this, you will see the trail and the file name of the selected file under the writing: "select application".

Flashing of software / delete flash / cancel:

Depending on what you intend, one of the following 3 buttons should be pressed:

- Delete flash (4): If the complete flash memory should be deleted and prepared for the new software, please press the button "delete flash". This is necessary if the software has to be installed for the first time on the basic board.
Do not delete the memory flash, if the current software should be updated.
- Standard flashing (9): If there exist already a software on the control board or if the flash memory was earlier deleted through the "delete flash " button, then use the "Standard flashing" button and the selected software afore will be flashed.
- Cancel (5): The current procedure (delete flash or standard flashing) can be cancelled through this "cancel" button. Depending on the progress of the procedure, is it possible that the software was already partly-implemented or not. If the blue progress bar you can still see with the deletion of the flash memory in the left half and then if the "cancel" button is pressed, the deletion of the flash memory will be cancelled. The deletion was not implemented at this time yet. The software played afore is still available after the restart.

You can see the progress of the selected procedure at blue progress bar (11) down on the screen. Depending on procedure, the progress goes faster or slower. After the start and before it ends, the progress bar is a certain time available on a screen.

Right down in the white status field (10) will be shown a message, which describes the current condition of the selected procedure. Here also error messages will be shown.

If a procedure was ended or cancelled, the reset button must be pressed on the control board which is going to be flashed (e.g. S1 reset on the control board A1 and/or S2 reset on the indicator board A2 of the brake test stand) or the machine with the control board which is going to be flashed must be switched off and on

g. End of the flashing procedure

The flashing procedure is completed, if the blue progress bar (11) disappears again, the buttons are activated again and in the status field appears a message. The message gives information whether the flashing procedure or deleting was successfully completed or not.

h. After flashing procedure:

- Switched off the machine
- The Jumper on the flashed board must be changed again. It can only be connected to one contact/pin.
- The serial cable can be taken off again. The occupied during flashing procedure serial interface, can be yet plug-in with the previous cable.
- For normal work with the new software the machine must be restarted.

14. Software update Touch PC

The software for the Touch PC is available as a zip file that needs to be unzipped to a USB stick. This zip File can be downloaded from the exclusive area (Infocenter) on www.nussbaum-group.de

- Switch the machine off, connect the USB stick to one of the USB ports on the lower side of the Touch PC
- Switch the machine on
- Touch the field in the right upper corner of the welcome screen two times



- Touch UPDATE



- Select „Update application with USB stick



- Touch Update and confirm the update
- After the Update has been done switch machine off and remove USB Stick
- Switch machine on, software version in upper right corner of the first screen needs to show the latest version i.e 01.22.50.27
- If the software on the basic board is not of the latest version an error message will be displayed and the update of the software of the basic board needs to be performed in order to bring the machine to work

CAUTION:

Make sure that the software for the Touch PC is always updated FIRST

15. Service Functions

The information on the service functions can also be found in the instruction manual

DIGITAL WHEEL BALANCERS



Via the function key  you get into the menu for service functions to select the basic settings or change them according to the user's requirements. The various menu functions from F1 to F14 can be selected by pressing the +/- keys

When you are in the function menu, an „Fn“ is shown on the left side of the digital display. The chosen function is shown on the right side of the digital display.

Once a particular function is desired, it can be chosen by pressing the function key again

F1 Precision reading of 1 Gram

F2 Zero run

The Zero run is provided to electrically compensate the unbalance of the adaptor or clamping means.

Whenever the clamping means has been dismantled and replaced a compensation of the residual unbalance in the adapter and clamping means should be carried out.

Routine:

MACHINES with manual clamping of the wheel

Remove the cones and clamp from the adaptor.
 Press the function key to select the function menu.
 Use +/- keys to select the Function 2.
 Press function key again to activate the function.
 Press START to start the run.

The residual unbalance of the adaptor is calculated and saved in the memory. (This value stays in the memory even after switching off the power). After the run has finished, the program automatically changes to normal mode.

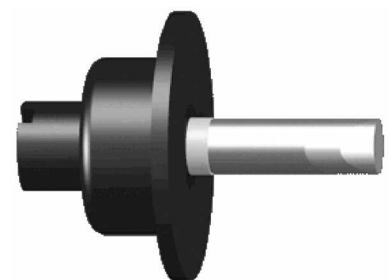

MACHINES with QuickSpan:

Attach the pressure cup for steel rims to the clamping sleeve and activate the QuickSpan
 Press the function key to select the function menu.
 Use +/- keys to select the Function 2.
 Press function key again to activate the function.
 Press START to start the run.

The residual unbalance of the adaptor is calculated and saved in the memory. (This value stays in the memory even after switching off the power). After the run has finished, the program automatically changes to normal mode.

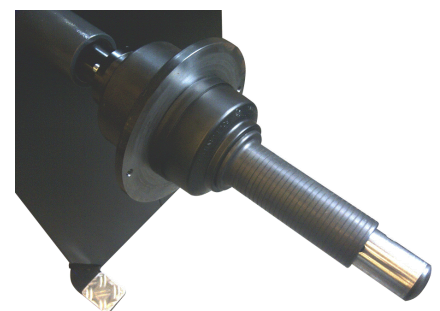

F 5 Calibration

The calibration weight supplied with the machine must be used together with the clamping adapter. Make sure that the threaded hole on the adapter is in line with the red indicator marking on the main shaft.

For calibration the calibration weight (1987009WG3) is required



MACHINES with manual clamping of the wheel

Remove cone and clamp from the main shaft.

MACHINES with QuickSpan:

Attach the pressure cup for steel rims to the clamping sleeve and activate the QuickSpan

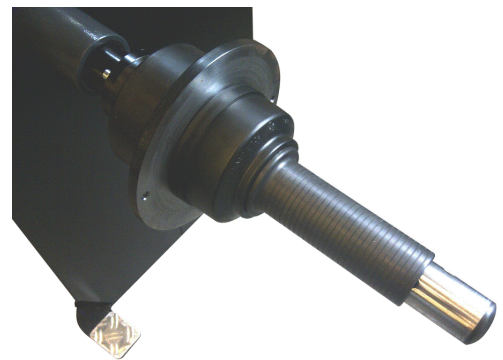

Press the function key to select the function menu.
Use +/- keys to select the Function 5.
Press function key again to activate the function.

There are 3 measuring runs performed during the calibration procedure, the wheel guard (if present) can be left open:

1. Measuring run

Run without calibration weight

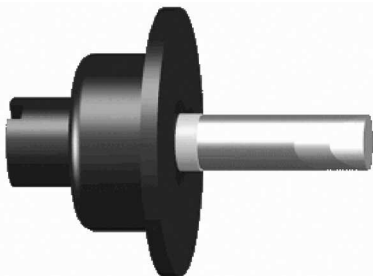

Machines with manual clamping of the wheel

QuickSpan

2. Measuring run

Run with calibration weight on the left side of the mid centering device

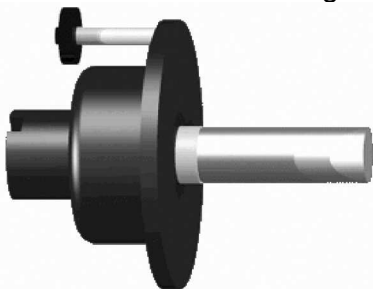

Machines with manual clamping of the wheel

QuickSpan

3. Measuring run

Run with calibration weight on the right side of the mid centering device

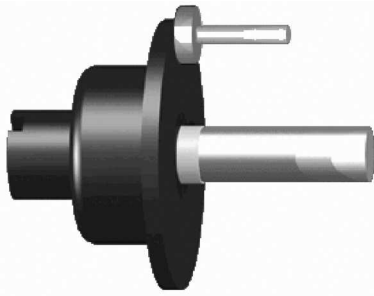

Machines with manual clamping of the wheel



QuickSpan

F 6 Autorun

If Autorun is active (ON) the balancing run is started when the wheel guard is closed. If Autorun is not active (OFF) the balancing run needs to be started by pushing the START button when the wheel guard is closed.

F 7 Suppression of minor imbalances / Round off

The suppression and rounding off of the balance results can be selected with this function
The suppression (lin) indicates below which value the imbalance is shown as „Zero“.

The round off (rnd) states in what steps the imbalance is displayed.

F 8 Wheel guard

SEC ON If the wheel guard is opened during the measuring run the wheel is stopped to an immediate standstill

SEC OFF If the wheel guard is opened during the measuring run the motor is switched off and the wheel runs free. This function is useful to view the run out of the wheel. As soon as the hood is closed again the measurement run will start again from the beginning

--- The wheel guard switch is put out of operation, the balancing run can be started with the wheel guard open

This function is only to be used for service purposes

F 9 Test function

With function F9 several ACTUAL values can be checked. This is helpful when a failure of the machine has to be analyzed.

Routine:

Press function key to select the function menu. Use +/- keys to select the Function 9.
Press function key again to activate the function.

The following data can be retrieved in the order stated below. Via the „+“ or „-“ button you can switch from one information to the other, the different data are paged through.
With reaching the last function value the program begins again with the first data (shaft position)

- Actual shaft position
This value can lie between 0 and 255 and changes with the rotation of the shaft.
- Actual distance of inner gauge arm
Is the PAX balancing program active (LED 19 PAX is light) the value is displayed in mm. The reference is the edge of the cabinet and when the gauge arm is in home position it should be 50 +- 5. The maximum value should be 325 +- 5
- Actual diameter of inner gauge arm
Is the PAX balancing program active (LED 19 PAX is light) the value is displayed in mm
The reference is the edge of the cabinet and when the gauge arm is in home position it should be 260 +- 5. The maximum value should be 650 +- 5
- Actual width
Is the PAX balancing program active (LED 19 PAX is light) the value is displayed in mm
The reference is the edge of the cabinet and when the gauge arm is in home position it should be 556 +- 10.
Is there no width gauge present the value 950 is displayed
- Actual position of the hood
The display will show the actual status of the wheel guard switch (OPEN or CLOSE)
- Status of the brake
The display will show the actual status of the brake (OPEN or CLOSE). If the ALU button is pressed the brake is activated (ON) or deactivated (OFF)
- Status of the QuickSpan
The display will show the actual status of the QuickSpan switch in the foot pedal (OPEN or CLOSE)
- Temperature
The temperature is measured in a range of 200 to 700 (corresponds to -20°C to +70°C)
Temperature < -20° C, Outside measuring range
Temperature > 70° C, Outside measuring range
- Cal. = Temperature at which the machine was calibrated
Act. = Actual temperature in 1/10 °C

F 10 Calibration of the gauges

! It is important that the gauges are always placed in the home position after measurements as this can result in inaccurate results.

! The brake should be released on all machines that have this function.

For the calibration of the gauges the calibration weight is required. It has to be attached to the mid centering device as shown in the left picture

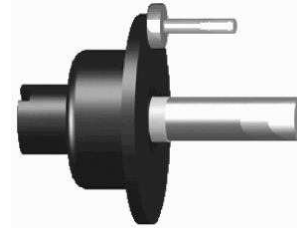

Step 1 – POS 1 - Distance

Extend the inside gauge to the position 1 and hold it there until an audible signal is heard, which means the measurement has been accepted

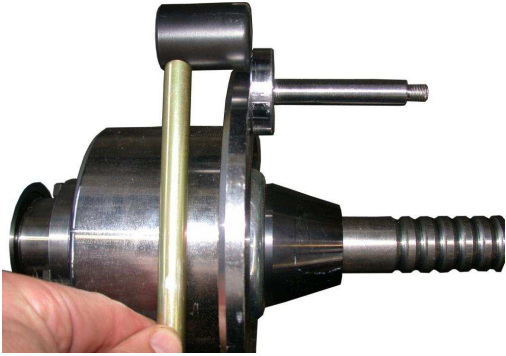

Step 2 – POS 2 - Diameter

Still in the extended position turn the gauge towards you into position 2 and hold until an audible signal is heard, which means the measurement has been accepted



Place the inside gauge back in the home position and an audible signal should be heard

With machines without an outside gauge the calibration procedure is complete and the program returns to normal mode.

Step 3 – POS 3 – Width (only when an outside gauge arm is present)

Bring the tip of outside gauge to the tip of the “long” end of the calibration weight and hold it in this position until an audible signal is heard, which means the measurement has been accepted.

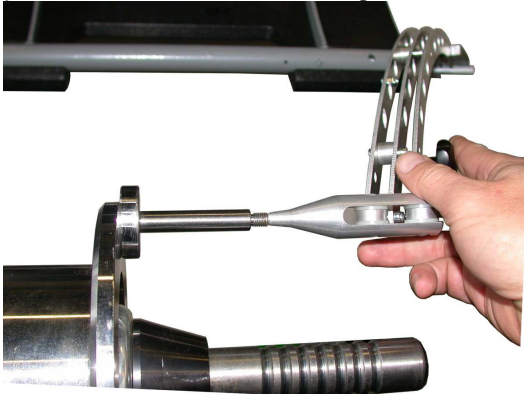

Return the outside gauge into the home position and an audible signal is heard and the program returns to normal mode

F 11 Counters

There are 3 counter values displayed that appear automatically one after the other with app. 10 seconds gap:

1. The first counter value shown is the total number of measurement runs since commissioning of the machine. The counter value shown on the display should be multiplied by 10 to get the actual value.
2. Number of measuring runs since last calibration.
3. Number of measuring runs since last power on of the machine.

After having displayed all counters the machine will change back automatically to normal mode

F 13 Setting of the brake

- br --- Brake active. After the measuring run the wheel is stopped in the left correction plane
- br Brake active. After the measuring run the wheel is stopped in the right correction plane
- --- Brake deactivated

F 14 Setting of automatic cycle

Automatic cycle ON means:

- The wheel will be stopped in the 1st imbalance position and locked
- After having attached the weights the wheel will be moved automatically into the 2nd imbalance position by pressing the STOP / POS button

Automatic cycle OFF means:

- The wheel will be stopped in the 1st imbalance position and locked
- Does the operator want to move the wheel into the 2nd imbalance position he has to push the STOP button in order to unlock the brake. In this case the wheel needs to be moved into the 2nd position manually and locked there by pushing the STOP button

TOUCH PC BALANCERS

When the area with the software version is touched twice coming from the first screen a service screen will be displayed.

In this screen there is an overview over all the functions

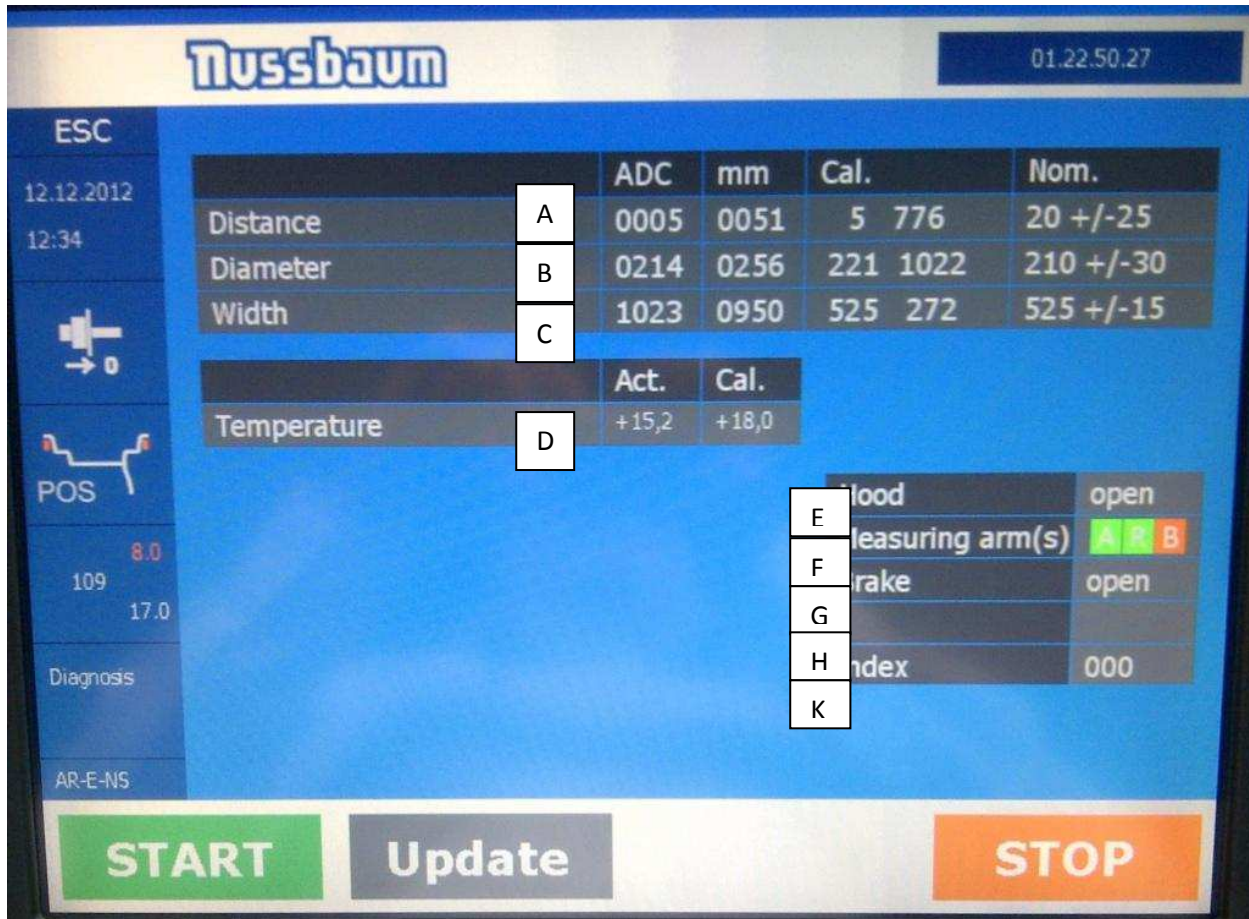

- A Actual distance of inner gauge arm
The reference is the edge of the cabinet and when the gauge arm is in home position it should be 50 mm +- 10
- B Actual diameter of inner gauge arm
The reference is the edge of the cabinet and when the gauge arm is in home position it should be 260 mm +- 10
- C Actual width
The reference is the edge of the cabinet and when the gauge arm is in home position it should be 556 mm +- 10
- D Temperature
The temperature is measured in a range of 200 to 700 (corresponds to -20°C to +70°C)
Temp < -20° C, Outside measuring range - Temp > 70° C, Outside measuring range

Cal. = Temperature at which the machine was calibrated

Act. = Actual temperature in 1/10 °C

- E Actual position of the hood
The display will show the actual status of the wheel guard switch (OPEN or CLOSE)

- F Indication if gauge arms are in the home position
GREEN = Gauge arm is located in home position
RED = Gauge arm is not in home position (also if gauge arm is not present or set out of operation)

- G Status of the brake
The display will show the actual status of the brake (OPEN or CLOSE)

- H Status of the QuickSpan
The display will show the actual status of the QuickSpan switch (OPEN or CLOSE)

- K Actual shaft position
This value can lie between 0 and 255 and changes with the rotation of the shaft.

16. Mid centring device (NOT QuickSpan)

a) In order to change the clamping means, switch off the machine. At the centre and inside of the threaded shaft there is a large securing bolt, which requires an Allen key, which comes with the standard scope of delivery (photo below) to loosen. Then take a rubber hammer and holding the shaft in one hand, slightly tap on the inside of the clamping means until it loosens from its mounting cone on the main shaft of the balance machine.

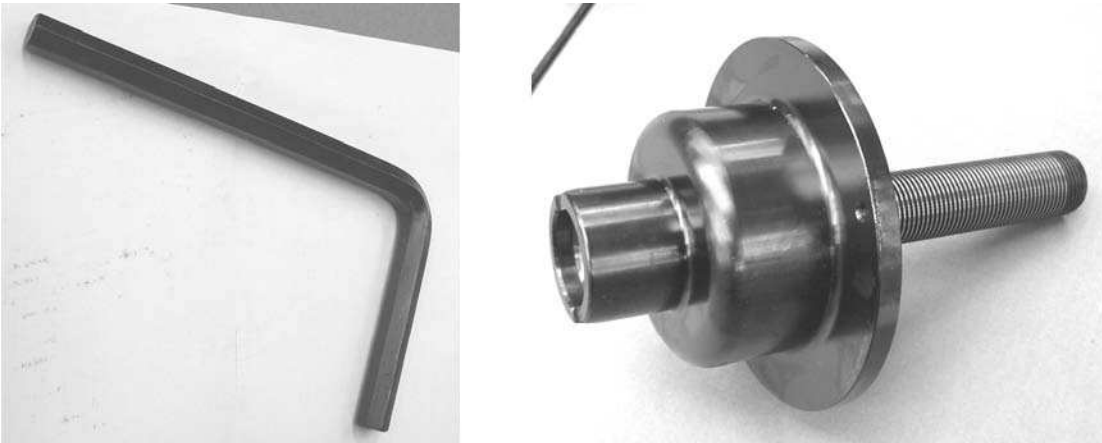

The left photo shows the Allen key used to loosen the clamping means on the right. The photo below shows the process of removing the clamping means.

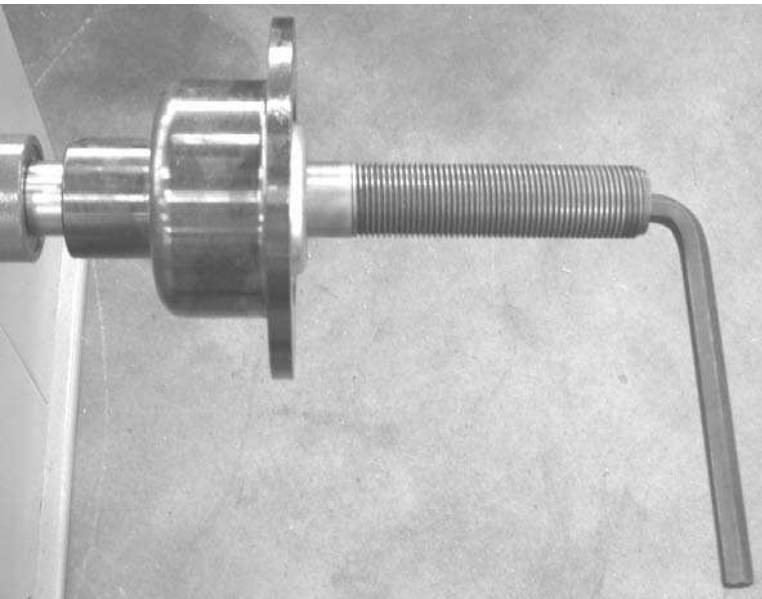

b) Before replacing the clamping means, clean the main shaft cone with a clean cloth. Before tightening the centre bolt, make sure that the position of threaded hole for the calibration weight aligns up in line with the red point on the main shaft.

c) Technical data

Diameter of the shaft is 40mm with a cone centre hole of SK40

Diameter of the trapezoidal screw thread TR40x3 is 40mm

17. QuickSpan

Principle

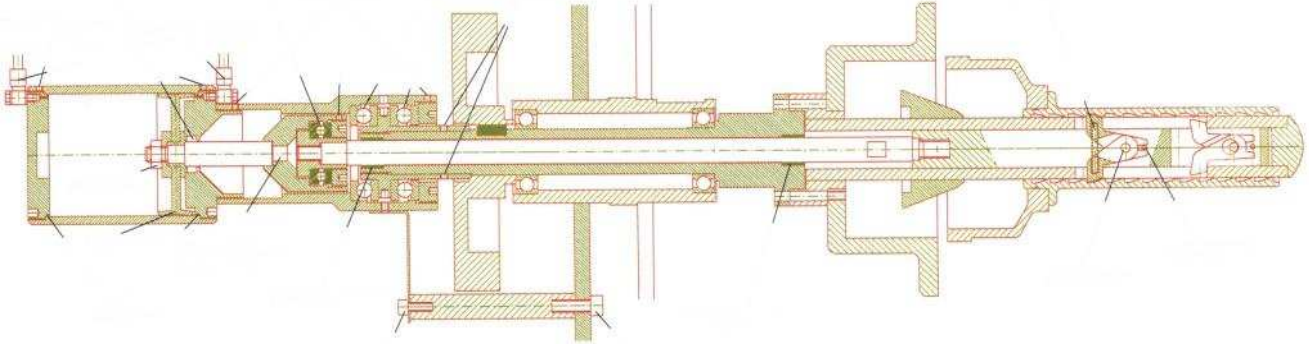

With the QuickSpan the wheel is clamped pneumatically upon foot pedal operation. The shaft diameter is 40 mm and all clamping accessories that can be used with the wheel balancers with manual clamping can also be used with the QuickSpan

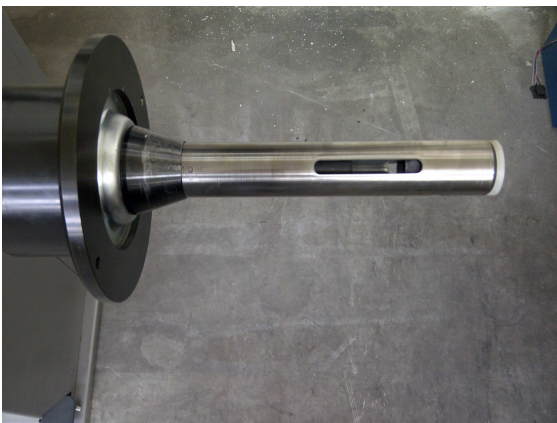

IMPORTANT: For calibration of the QuickSpan machines as well as the zero run the clamping sleeve and the clamping hood for steel rims as shown in the pictures below. **NO cone shall be used**

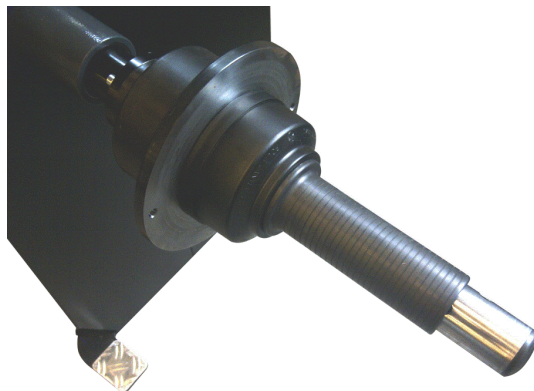
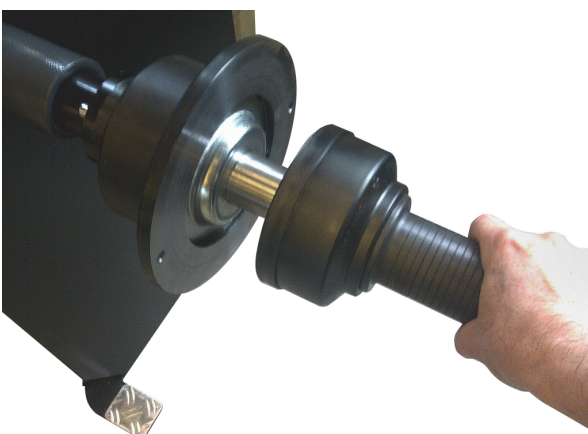

For more information on calibration and zero run please see the instruction manual

18. Foot pedal (QuickSpan)

a) The foot pedal is used to clamp the wheel to the main shaft and is NOT designed to be used as a brake to hold the main shaft.



b) The pedal is part of a metal plate, which is constructed with a small bolt attached to relieve the pressure of someone applying full force to the pedal and damaging it after a while. If this screw is set in the wrong position, it can lead to the breakdown of the mechanical switches or that the switch point cannot be reached due to the brakes being applied too early. Loosen the securing nut and turn the adjuster in the desired position. Tighten the securing screw afterwards.

c) The foot pedal switch works as an opener, meaning the following:

- If the foot pedal is not operated at all the switch is closed
- If the foot pedal is pushed and hold in the push position the switch opens

The measurement of the resistance between the contacts 3 and 4 on the cable from the foot pedal switch brings the following results

- Foot pedal not operated Connection between contacts 3 and 4 (resistance = 0)
- Foot pedal operated and hold No connection between contacts 3 and 4 (high resistance)

Please note that the software does check the foot pedal switch during power on and based on the status of the switch does activate the QuickSpan function or not. This means that, if the foot pedal is pushed during “power on” of the machine it can happen that the software does recognize an open switch and puts the QuickSpan out of operation.

It is important to leave the machine untouched during the power on process, especially on a machine with Touch PC as the power on takes some time

If there is not any difference in behavior of the switch when operating the pedal or leave it this can have 2 reasons:

- The foot pedal switch is defect
- The mechanical connection between the foot pedal itself and the switch does not allow to operate the switch

19. Maintenance unit (QuickSpan)

The photo below shows the air pressure control unit for the quick span machines.



Screw to operate the QuickSpan valve manually for testing purposes

The maintenance unit is equipped with a water separator, an oiler and a pressure gauge. The pressure is reduced to 6 bar and **must not** be adjusted to a higher value.

The oiler needs to be checked on a regular basis in order to make sure that there is always enough oil present.

Running the QuickSpan without oil can lead to a malfunction of the complete system

The operating pressure should be between 8 – 10 bars to enable a wheel to be clamped correctly. The air pressure magnet valve is controlled by the motor control board. (See chapter on motor control board).

In order to check that the valve is working fine manually it can be operated by turning the screw as indicated above.

The solenoid valve of the maintenance unit is operated with 32 Vac

20. Repair Instructions for clamping fingers (QuickSpan)

REQUIRED PARTS

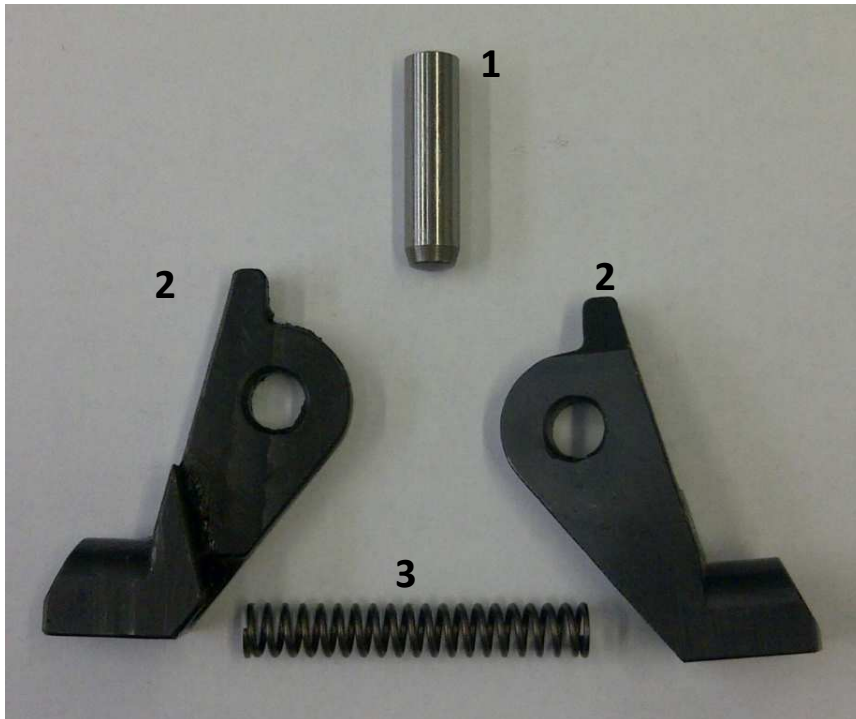

Repair kit 1987009W8LA

1. Splint
2. 2 x Clamping fingers
3. Spring

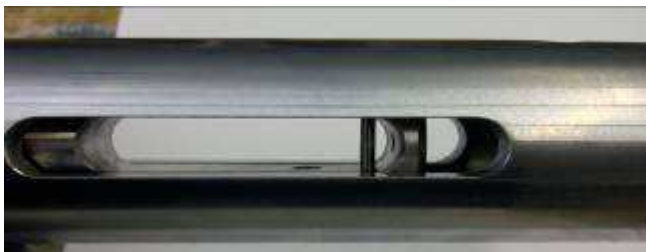

Position the pull shaft in the 40 mm shaft so that the clamping fingers and the spring can be mounted



Assemble and grease well the two clamping finger and the spring



Insert the the clamping fingers and the spring into the pull shaft



Position the clamping fingers and the spring such that the splint can be fitted



Mount the splint



While the pin is mounted with a hammer, always make sure that the two fingers do move well

Once the pin has been installed check that the pull shaft can be easily moved back and forth inside the 40 mm shaft

!!!! Perform a calibration and a zero run !!!!

21. Using UNI-LUG and Motorcycle adaptor on QuickSpan

1987009W8JA

Adapter kit to mount motorcycle adaptor and Universal flange to QuickSpan wheel balancers



1 adaptor
4 tapered screws M 6 x 25 to pre centre the cone adaptor and the flange

MOUNTING INSTRUCTIONS



Remove the 4 screws holding the flange



When all screws have been removed open the QuickSpan via the foot pedal



Move the flange away from the cabinet until the pull rod is seen

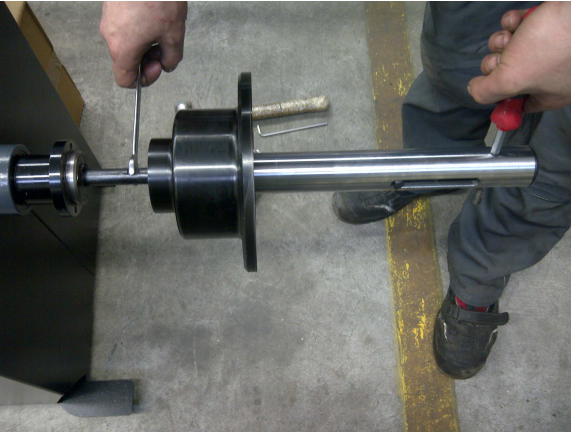

Unscrew the flange using the 13mm wrench and a screwdriver as shown



Move the pull rod via the foot pedal to the back (clamp QuickSpan)

**DISCONNECT THE AIR SUPPLY TO PREVENT THE QUICKSPAN TO UNCLAMP UNEXPECTEDLY
Which may result in an internal damage**



Attach the adapter to the balancing unit



Pre centre the adapter using the delivered tapered screws



Replace the tapered screws with the „original“ helical screws and tighten them crosswise

After having tightened all 4 „original“ helical screws put the motorcycle adaptor or the universal adaptor on the cone and tighten it with the screw (Shaft of the motorcycle adaptor / 16mm screw on universal adaptor)

Perform a zero run (refer to instruction manual for more information)

Retrofit mid centring device

Remove the 4 screws and demount the adaptor from the balancing unit



Connect the machine to the air supply and move the pull rod out by using the foot pedal

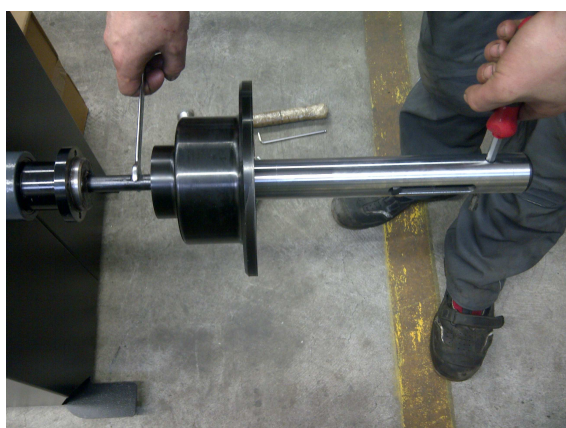

Place the flange on the pull rod and tighten it using a 13 mm wrench and a screwdriver



Push the flange back so that the pull shaft is located in the middle position (see picture below)



Position the flange on the balancing unit in a way that the point on the balancing and the calibration thread on the flange are in line



Pre centre the flange on the balancing unit using the 4 tapered screws



Replace the tapered screws with the „original“ helical screws and tighten them crosswise

Perform a zero run (refer to instruction manual for more information)

22. Trouble shooting and problem solving

The following lists show the possible problems that might occur and some solutions how to solve them. This list can be expanded and it is advised to check frequently on our home page under Service/ frequently asked questions. Go through the remedies one by one until the problem is solved. If the problem cannot be solved after trying all these possibilities, please report to a Nussbaum technician.

"E7 Ind", index error

Problem in recognizing the optical encoder board

Remedy:

- Push the board slightly down or lift it slightly up in order to achieve the right distance

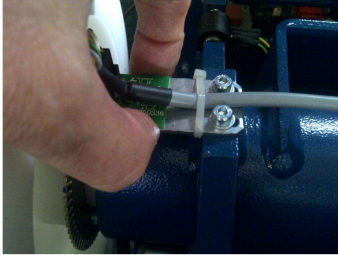

- Check that all cables are well connected to the connectors
- Check if the opto encoder is recognized with Service function F 9

"E10 dir", direction error

- The opto encoder recognizes that the shaft is turning in the wrong direction

"E11 Mot" Drive problem (brake, opto encoder, belt)

Remedy:

- Push the board slightly down or lift it slightly up in order to achieve the right distance (see E7 Ind)
- Check that all cables are well connected to the connectors
- Check if the opto encoder with Service function F 9
- Check if motor is defect
- Check if belt is tight enough

Problem

On switching on the machine, the display does not illuminate.

Remedy

Check the mains power supply. It should be between 230V +/- 10%, and 110V +/-10% depending on model. If the mains supply has a tendency to fluctuate, it is advised to protect the machine electronics from damage by using a voltage regulator.

- Check the main on/off switch to make sure that it is not malfunctioning. If damaged, replace.
- Check the main fuse X1-F1 on the terminal strip. Change if necessary.
- Check fuses F1-F4 on the motor control board. Replace if necessary
- Check the voltage coming from J6 on the motor control board. If no voltage shown, change board.
- Check voltage from J9 of the basic board. If voltage is wrong, check the connection leads.
- Check the jumper J13 on the basic board. They should be open for normal operation and closed for flashing new software. Replace as to requirements.
- Check the Basic board on another machine if possible.

Problem

Fluctuating results after repetitive balance runs

Remedy

Make sure that the correct cone has been used for the wheel and that the clamp is secure and tight on the clamping means.

- Check that the machine is on level hard ground. If necessary bolt machine to the ground. Never use machine when it is bolted on a wooden pallet.
- Check the software version. Update if it is lower than 1.6. Software can be downloaded from our home page.
- Check Piezo sensors - Make sure they are tightened to exactly 2 Nm and that the securing nut is tight. Check the cables and connectors that they are secure and in good condition.
- Check the bearing play in the main shaft. IF there is too much play, make sure that the belt pulley securing bolt is tightened to 10Nm securing with Loctite. If the bearing play cannot be relieved, change the mains haft assembly.
- Make sure that the clamping means is clean and tight on the main shaft. Check the tightness of the securing bolt and clean clamping means completely with a clean dry cloth.

Problem

0 – 0 Cannot be achieved after correcting unbalance with weights

Remedy

- The wrong program might have been chosen- the program is not suitable for the required weight position
- Wheel data not correct – Check that the inputted wheel data corresponds exactly to that of the wheel and the program.
- Zero run and/or calibration run have not been done correctly. Carry out again according to instructions in the user manual.
- Clamping means is not correctly tightened. Check and clean all parts.
- Position of the clamping means on the main shaft is incorrect. The threaded hole for the calibration weight should be in line with the red marking on the main shaft axis. (see installation instructions)
- Check the position of the clamping means. LED machines, select F9 and rotate the shaft until P0 is reached. The threaded hole in the clamping means should be in 12 o'clock position. If not, reposition.
- Check if the opto encoder is mounted and positioned correctly. Opto encoder LED 1 and 3 and 2 should light and extinguish. The point 0 is shown when LED 3 extinguishes and stays out.
- Check the free running of the main shaft. By tightening the bolt on the end of the shaft the main shaft can be tightened.
- Make sure the 4 securing bolts for the main shaft assembly are secure. Tighten if necessary.
- Check to see that there is no contact between the axis of the main shaft assembly and the cabinet body.
- Check to make sure the Piezo sensors are fitted correctly. Too loose and they give false readings, too tight they become damaged. Sensors should be fitted according to service instructions. Every time work has been carried out with the sensors, a new calibration should be carried out.

Problem

Inside arm gives incorrect readings for the distance and diameter of the wheel

Remedy

- The chain for distance gauge is not fitted correctly to the chain pulley. Loosen the pulley mechanism and replace according to the service instructions
- Connection J8 is not in contact with the basic board. Check connections and leads.
- Inside arm calibration is incorrect. Select F10 and carry out the routine according to user handbook.
- Check the resistance of the potentiometer with a multi meter. It should read about 10k ohms. If it is less, change the potentiometer.
- Check fuses F4 and F5 on the motor control board. Change if necessary. (160mAT).

Problem

No reaction after pressing any buttons on the monitor machines in conjunction with the user manual

Remedy

- Check the serial cable connection from the Touch PC to the basic balancing board
- Make sure that the basic board and the Touch PC are started at the same time, i.e. after switching the machine on.
If the Touch PC is switched off and on again without switching off and on the complete machine there is no synchronization between the basic balancing board and the Touch PC

Problem

Machine does not start in automatic mode after closing the wheel guard.

Remedy

- Check the functions F6, or under the menu settings in the main menu. If required, select ON position.
- Check the wheel guard micro switch is functioning properly. Make sure it is not damaged and that the cam is sitting on the shaft in the correct position.
- Check the connection leads and connectors. The leads should not be damaged and all connections secure. If necessary exchange leads.

Problem

Quick span-clamping means does not work

Remedy

- Check the air pressure at the maintenance unit. The air pressure for the cylinder is limited to 6 bar.
- Make sure the foot pedal is working. Check that the mechanical function together with the adjustment bolt is correct.
- Check the connection leads for mechanical damage and all connections for security. If necessary exchange.

23. Electrical schematic layout

Basic Board

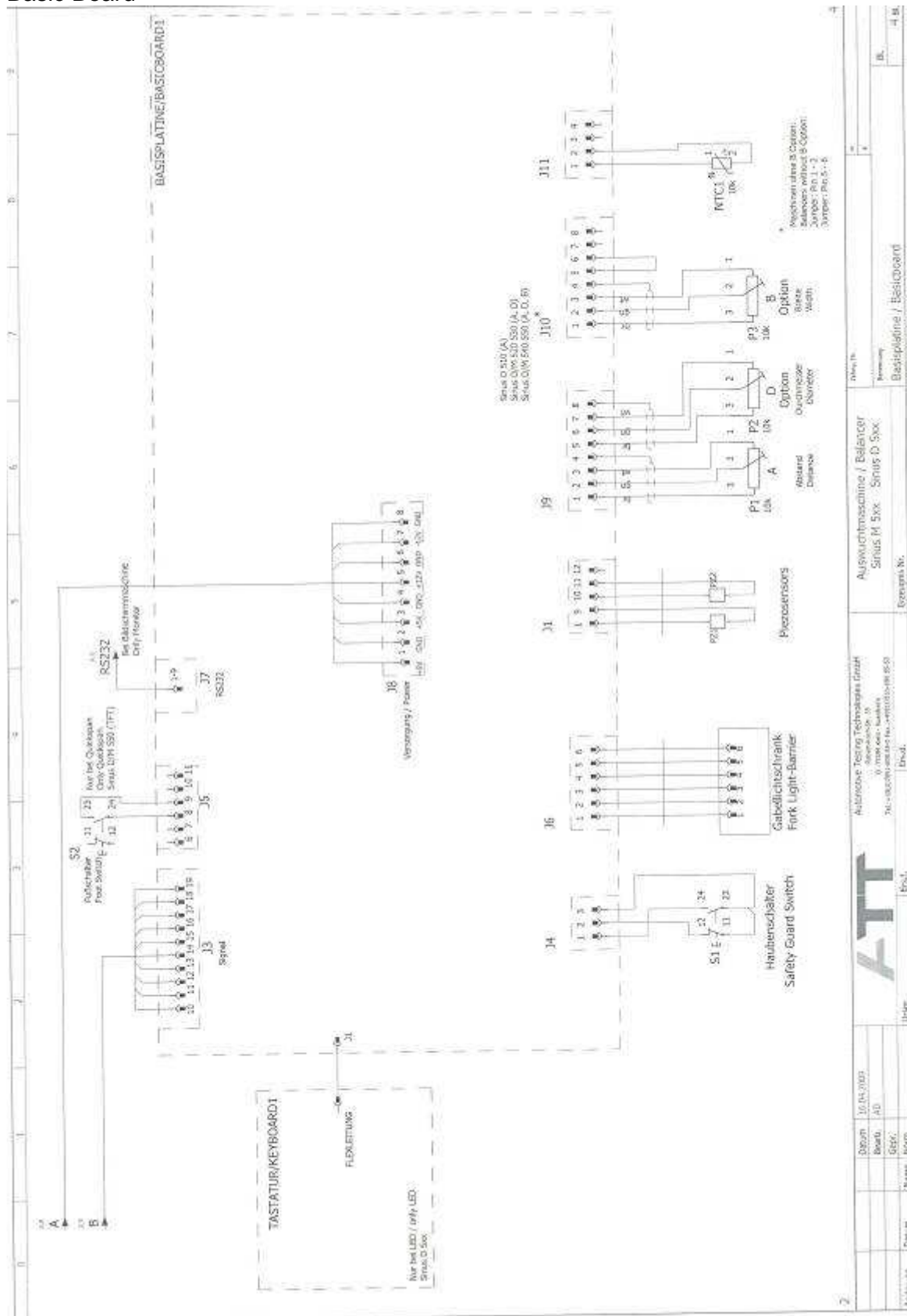

Motor control board

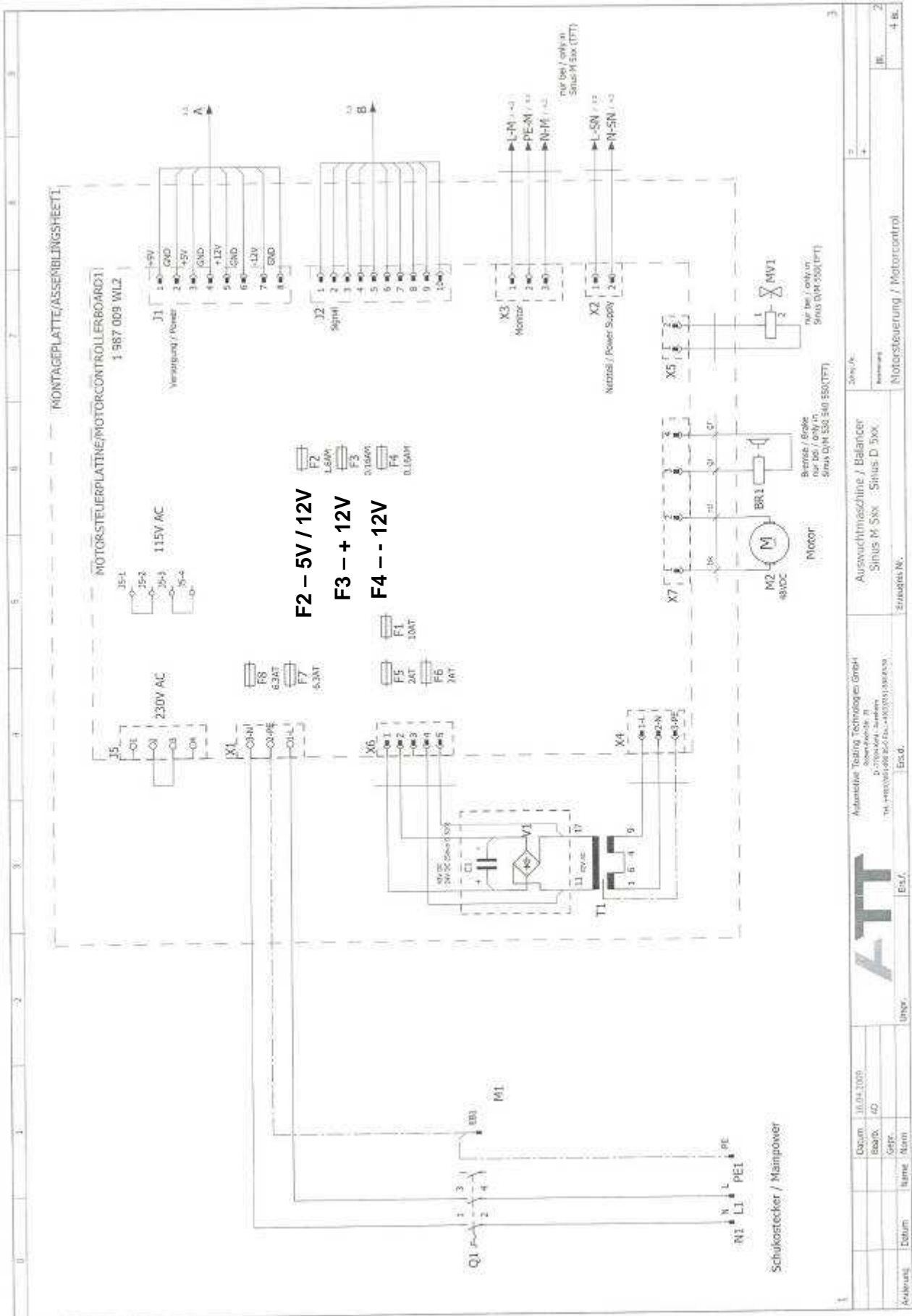

MONTAGEPLATTE/ASSEMBLY SHEET	
MOTORSTEUERPLATTE/MOTOR CONTROL BOARD 01 1 987 009 WL2	
Versorgung / Power	
230V AC	
115V AC	
F2 1.5A 5V F3 0.7A 12V F4 0.15A 12V	
F5 2A 12V F6 7A 12V F7 5.3A 12V F8 6.3A 12V	
X1 Monitor X2 Versorgungs / Power Supply X3 Monitor X4 PE X5 Signal X6 Signal X7 Signal	
M1 Motor M2 48VDC Motor BR1 Brücke / Bridge MV1 Photo eye / only in Sinus Box (PTT)	
230V AC 115V AC 5V 12V GND L-M PE-M N-M L-SN N-SN	
Docum. 16.04.2019	230V AC
Board ID	+
Gepr. Name	+
Gepr. Name	+
Gepr. Name	+
Gepr. Name	+
Gepr. Name	+
Auswuchtmaschine / Balancer SINUS M 500 · Sinus D 500	
Motorsteuerung / Motorcontrol	
Autonexte Tooling Technologies GmbH D-72544 Marzling Th. Hees / Telefon 07141 2140 101 / Fax 07141 2140 102	230V AC
ESL	ESL
Unger	Unger
ESL	ESL
ESL	ESL

24. Dimensions

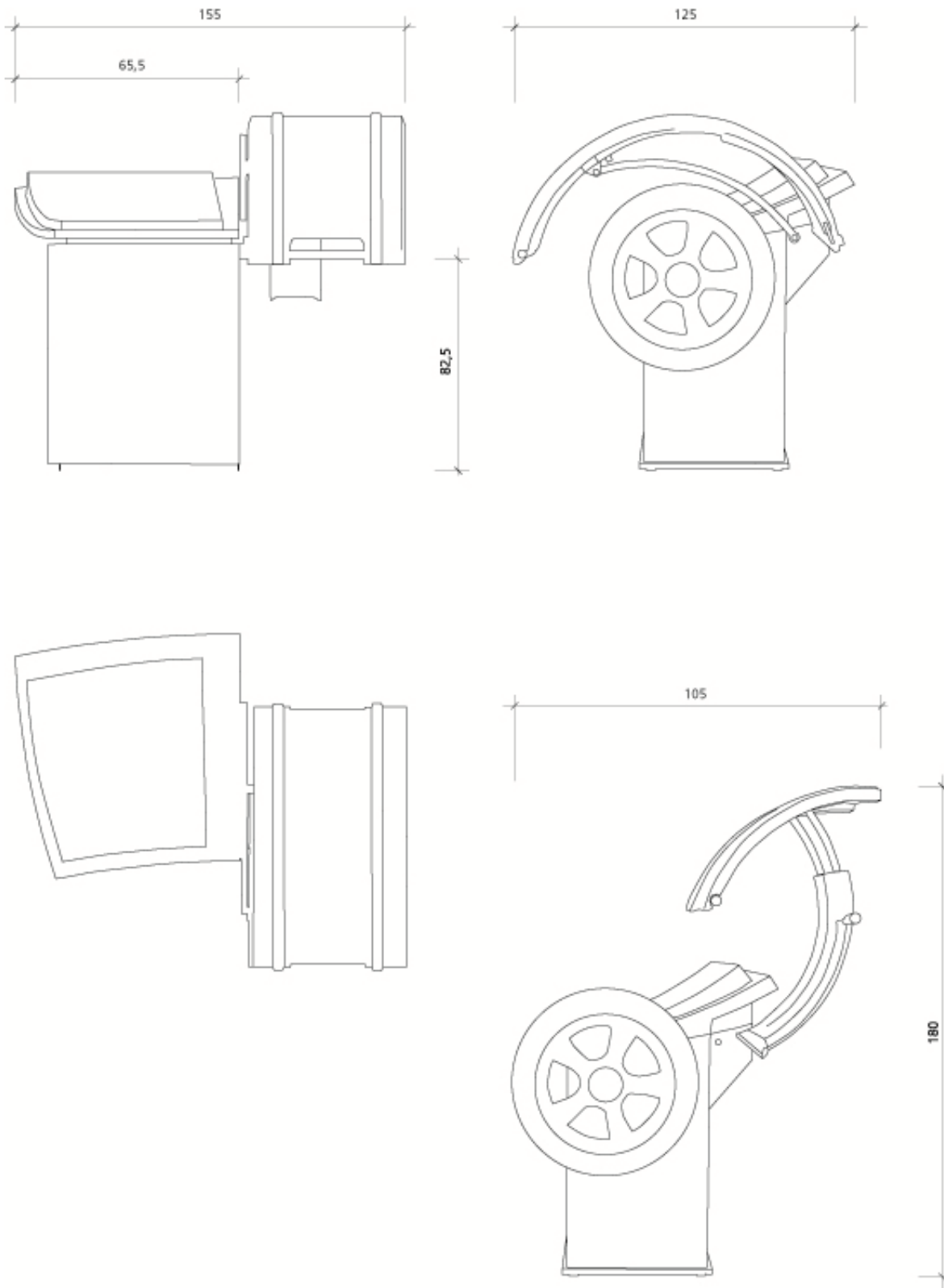

25. Technical data

	BM 11	QuickSpan champ	BM 15 Touch	QuickSpan champ Touch	BM 30-2	QuickSpan comfort	BM 35 Touch	QuickSpan comfort Touch	BM 40-2	QuickSpan chrome	BM 45 Touch	QuickSpan chrome Touch
Automatische Erkennung Wuchtprogramm	✓	✓	✓	✓	✓	✓	✓	✓	✓	✓	✓	✓
Mehrstufige Berechnung Fingerbreite	✓	✓	✓	✓	✓	✓	✓	✓	✓	✓	✓	✓
Elektronische Halbbrücke	-	-	-	-	-	-	-	-	-	-	-	-
Automatisches Anfahren 1. Umwuchsposition	-	-	-	-	-	-	-	-	-	-	-	-
Automatisches Anfahren 2. Umwuchsposition	-	-	-	-	-	-	-	-	-	-	-	-
Manuelle Regelspannung	-	-	-	-	-	-	-	-	-	-	-	-
Pneumatische Radluftspannung QuickSpan	-	✓	-	-	-	-	-	-	-	-	-	-
Halber für 5 Können	1987000WVWJN 1987000WVWJN	1987000WVWJN 1987000WVWJN	1987000WVWJN 1987000WVWJN	1987000WVWJN 1987000WVWJN	1987000WVWJN 1987000WVWJN	1987000WVWJN 1987000WVWJN	1987000WVWJN 1987000WVWJN	1987000WVWJN 1987000WVWJN	1987000WVWJN 1987000WVWJN	1987000WVWJN 1987000WVWJN	1987000WVWJN 1987000WVWJN	1987000WVWJN 1987000WVWJN
Radbremse	✓	✓	✓	✓	✓	✓	✓	✓	✓	✓	✓	✓
Avantaje	Digital LED	Digital LED	15" Touch Monitor	15" Touch Monitor	Digital LED	Digital LED	15" Touch Monitor	15" Touch Monitor	Digital LED	Digital LED	15" Touch Monitor	15" Touch Monitor
Messreichweite (cm)	< 100	< 100	< 100	< 100	150	150	150	150	150	150	150	150
Durchmesser Welle (mm)												
Durchmesser desch Mfendloch (mm)												
Folgerbreite (Zoll)					43 - 111,5							
Folgerdurchmesser (Zoll)					1 - 20							
Max. Radbreite (mm)					8 - 34							
Max. Radbreite (mm)					530							
Max. Radbreite (mm)					900							
Max. Radbreite (mm)					70							
Übernahme ABS FAKD					Automatisch							
Übernahme DURCHMESSER					Automatisch							
Übernahme BERSTE												
Abmessungen H x B x T (mm)	1570 x 1200 x 770	1570 x 1200 x 770	1570 x 1300 x 770	1570 x 1200 x 770	1800 x 1550 x 1050	1800 x 1550 x 1050	1800 x 1550 x 1050	1800 x 1550 x 1050	1800 x 1550 x 1050	1800 x 1550 x 1050	1800 x 1550 x 1050	1800 x 1550 x 1050
Radbreite B x T (mm)	1700 x 1300	1700 x 1300	1700 x 1300	1700 x 1300	1700 x 1600	1700 x 1600	1700 x 1600	1700 x 1600	1700 x 1600	1700 x 1600	1700 x 1600	1700 x 1600
Gewicht (kg)	ca. 124	ca. 125	ca. 125	ca. 125	ca. 135	ca. 135	ca. 135	ca. 135	ca. 135	ca. 135	ca. 135	ca. 135
Netzspannung (V)					200 - 240 Volt, 1 ph / 50, 60 Hz	200 - 240 Volt, 1 ph / 50, 60 Hz	200 - 240 Volt, 1 ph / 50, 60 Hz	200 - 240 Volt, 1 ph / 50, 60 Hz	200 - 240 Volt, 1 ph / 50, 60 Hz	200 - 240 Volt, 1 ph / 50, 60 Hz	200 - 240 Volt, 1 ph / 50, 60 Hz	200 - 240 Volt, 1 ph / 50, 60 Hz
					Anzahl Spannungen auf Anfrage							
LIEFERUMFANG												
Mittelpointierung / 3 Können / Quickmutter / Druckkopf	✓	✓	✓	✓	✓	✓	✓	✓	✓	✓	✓	✓
3 Können / Spannhülse / Druckkopf	-	✓	-	-	-	-	-	-	-	-	-	-
Folgerbreite/Anfahr	✓	✓	✓	✓	✓	✓	✓	✓	✓	✓	✓	✓
Kabelgewichte Erdenerne	✓	✓	✓	✓	✓	✓	✓	✓	✓	✓	✓	✓
Gewichtsmenge	✓	✓	✓	✓	✓	✓	✓	✓	✓	✓	✓	✓
Kalibergewicht	✓	✓	✓	✓	✓	✓	✓	✓	✓	✓	✓	✓
	✓	Standard Lieferumfang										
	-	Nicht möglich										
	1987000WVWJN	Als optionales Zubehör erhältlich										