

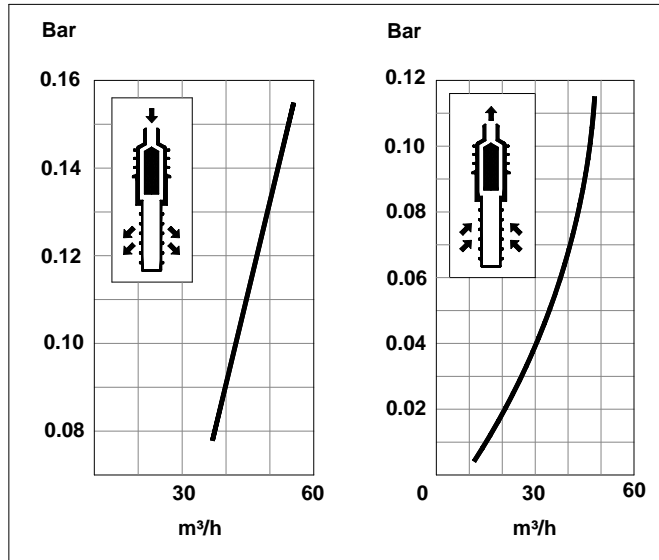

Valves

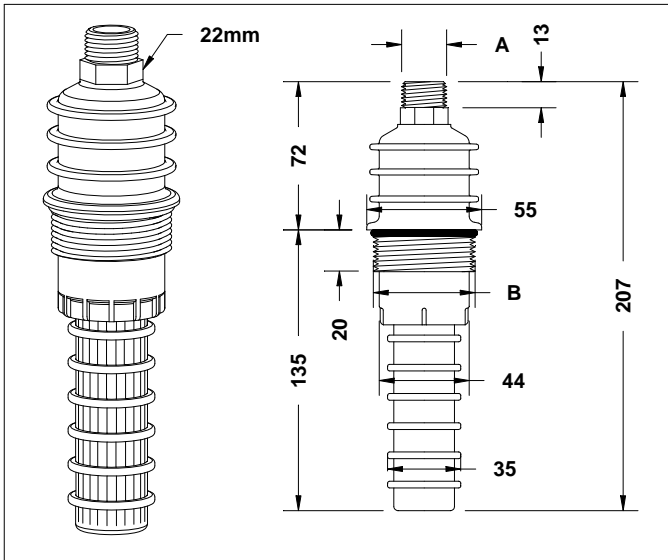

AERATION VALVE
BE- UND ENTLUFTER
PURGEUR D'AIR / CASSE-VIDE

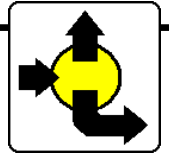
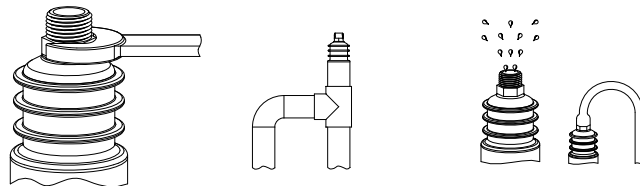
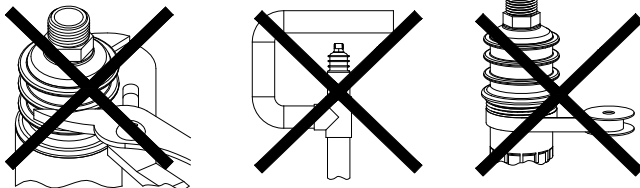

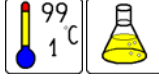
Type Type Type	Thread A Gewinde A Fillet A	Thread B Gewinde B Fillet B	Material Material Matière	 1
	1/2" BSP	1 1/2" BSP	PP-GF/EPDM	A-AV-150PP
	1/2" NPT	1 1/2" NPT	PP-GF/EPDM	
	1/2" BSP	1 1/2" BSP	PVDF/FPM	A-AV-150PVDF
	1/2" NPT	1 1/2" NPT	PVDF/FPM	