

Description

The rack and pinion pneumatic actuator IA Motion combines innovative design features with the latest technology, materials and protection coatings available, resulting in one of the highest grade pneumatic actuators on the market.

Product features

- Function **IA...D** double acting
IA...S single acting
- Nominal torque 15 ÷ 10007 Nm
(double acting at 6 bar air supply)
- Supply pressure 3 ÷ 8 bar (IA1000D 3 ÷ 7 bar)
- Supply fluids Filtered air or neutral gas
- Working temperature -40°C ÷ 80°C
- Connection Mounting face for valves according to EN ISO 5211,
for solenoid valves and accessories to VDI/VDE 3845 (NAMUR)
- Lubrication Factory lubricated for the life of actuator
under normal working conditions
-  ATEX Actuator IP68, standard in compliance with ATEX 94/9/EC

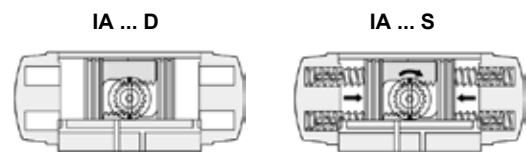

Design properties

- Compact design with identical body and end caps for double acting and spring return types, allowing field conversion by adding or removing spring cartridges.
- Body made of extruded aluminium with internal and external ALODUR® corrosion protection, with honed cylinder surface for a higher cycle life and lower coefficient of friction.
- Symmetric rack and pinion design for high-cycle life and fast operation. Reverse rotation can be accomplished by inverting the pistons.
- Two independent external travel stop adjustments, enabling an easy and precise adjustment of -5°÷15° / 75°÷95°, in order to get a precise valve positioning.
- One-piece blow-out proof, electroless nickel-plated drive shaft with bearing guided one-piece pinion for improved safety and max. cycle life.
- Fully machined piston teeth for accurate low backlash rack and pinion engagement and maximum efficiency.
- Pistons standard anodized for higher life.
- Multifunction position indicator, adaptable to all kinds of limit and proximity switches.
- Preloaded spring cartridges with coated springs for simple versatile range and corrosion resistance. Spring return actuator can be disassembled without danger on field.
- High quality bearings and seals for low friction, high cycle life and a wide operating temperature range.
- End caps, anodized and Polyester® coated (RAL 5021).
- All used screws in stainless steel for life time corrosion resistance.
- Full compliance to the latest specifications: EN ISO 5211, VDI/VDE 3845, NAMUR and ATEX (Directive 94/9/CE).
- Every single actuator is tested and provided with a unique serial number for traceability.

Your benefits

- High quality actuator designed for high-cycle life.
- Multiple mounting circles and shafts to fit most quarter turn valves.
- Easy conversion from double to single acting and vice versa.
- Lower inventory with greater flexibility.
- Position indicator with graduated ring indicating accurate angle.
- Two external travel stop adjustments for easy valve positioning -5° to $+15^{\circ}$ / 75° to $+95^{\circ}$.
- Extensive size range to fit the requested torque at lowest costs.
- Full compliance to latest worldwide standards.

Materials

Body	Extruded aluminium EN AW-6063, ALODUR® corrosion protected (IA045-750), anodized and polyurethane coated (IA800-1000)
End caps	EN AC-46000, anodized and Polyester® coated (RAL 5021)
Pistons	EN AC-46000, anodized
Springs	SiCr spring alloy steel, Epoxy coated
Shaft	C22, nickel plated
Position indicator	PA66 + 30%GF + carbon black

Function

IA...D double acting actuator

Air supplied to port ② moves pistons toward end position.
(→ 90° counterclockwise rotation)

Air supplied to port ④ moves pistons toward center position.
(→ 90° clockwise rotation)

IA...S single acting actuator

Air supplied to port ② moves pistons toward end position, compressing springs
(→ 90° counterclockwise rotation)

Air failure allows springs to move pistons toward center position
(→ 90° clockwise rotation)

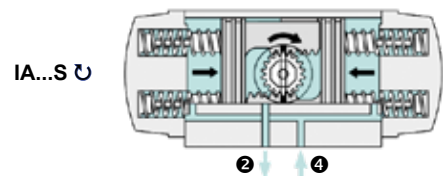
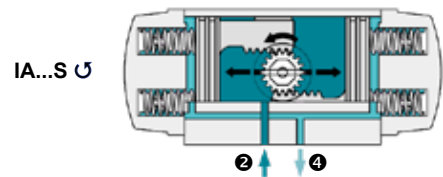
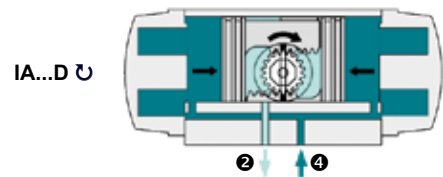
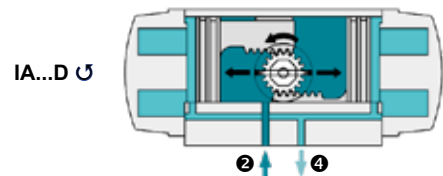
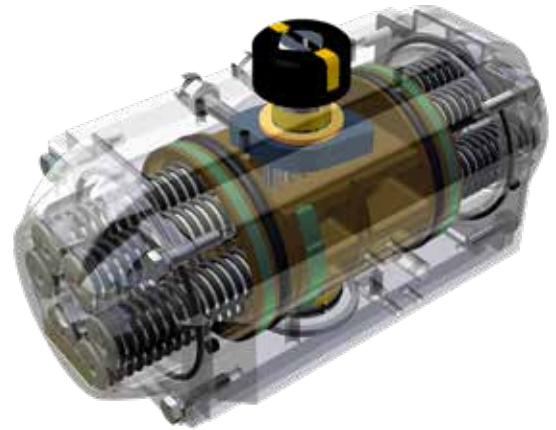
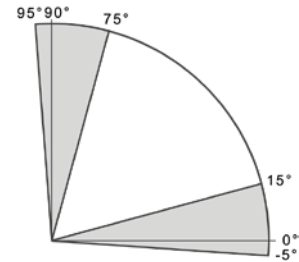

Type code

IA200 D . F05 - F07 14

① ② ③ ④

① Actuator size	IA045 - IA1000	
② Function	D	Double acting
	S12	Single acting + number of springs
③ Mounting face for valve	F03 - F30	According to EN ISO5211
④ Shaft connection	[mm]	Dimension of shaft connection

Available options:

- 5 different external coatings.
- Stainless steel AISI 303, 430 or 316 drive shaft.
- High and low temperature versions.
- $0 \div 90^\circ$ adjustable travel stop.
- Cost efficient lock out capability.
- Other drive shaft connections.
- Rotation 120° and 180° and intermediate such as 135° .
- 3 position actuators.
- Stainless steel actuators.

Please contact our technical department for more information about these options.

$0 \div 90^\circ$ adjustable travel stop

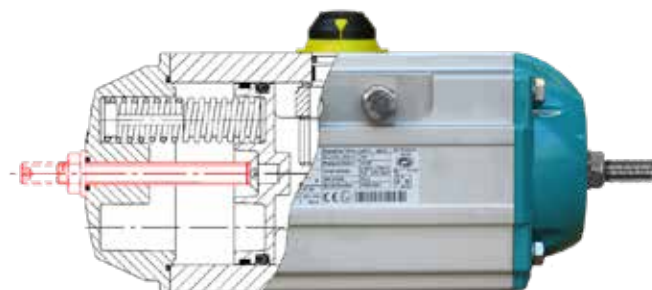

Torques [Nm]

IA...D - Double acting actuators

	Pneumatical torque at air supply of					
	3 bar	4 bar	5 bar	6 bar	7 bar	8 bar
IA 045 D	7,2	9,6	12,0	14,4	16,8	19,1
IA 050 D	10,0	13,3	16,6	19,9	23,3	26,6
IA 100 D	17,6	23,5	29,3	35,2	41,0	46,9
IA 200 D	34,9	46,5	58,2	69,8	81,4	93,1
IA 250 D	54,9	73,2	91,5	109,8	128,1	146,4
IA 300 D	79,8	106	133	160	186	213
IA 350 D	129	172	215	258	301	344
IA 400 D	166	222	277	332	388	443
IA 450 D	261	348	435	522	609	696
IA 500 D	340	454	567	681	794	908
IA 550 D	459	613	766	919	1072	1225
IA 600 D	638	851	1064	1276	1489	1702
IA 650 D	1072	1430	1787	2144	2502	2859
IA 700 D	1556	2075	2594	3112	3631	4150
IA 750 D	2154	2872	3590	4308	5026	5744
IA 800 D	2703	3604	4504	5405	6306	7207
IA 1000 D	5003	6671	8339	10007	11674	-

IA...D

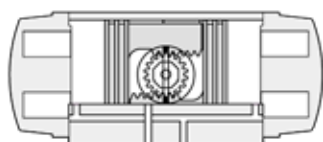
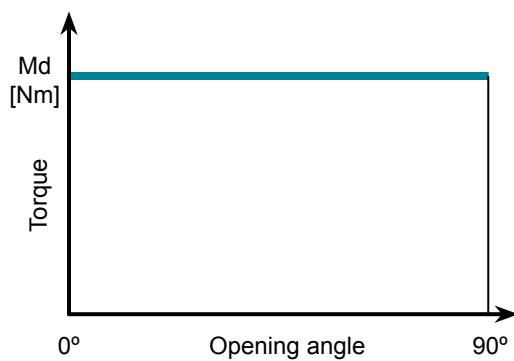

IA...S

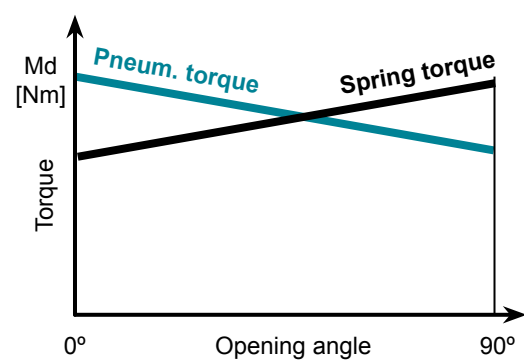

Torques [Nm]

IA...S - Single acting actuators

		Pneumatical torque at air supply of												Spring [Nm]	
		3 bar		4 bar		5 bar		6 bar		7 bar		8 bar		90°	0°
		0°	90°	0°	90°	0°	90°	0°	90°	0°	90°	0°	90°	90°	0°
IA045	S 12	4,7	2,4											4,8	2,6
	S 22			6,1	3,2	8,5	5,6							6,4	3,5
	S 33							9,4	4,8	11,8	7,2	14,1	9,5	9,6	5,0
IA050	S 06	6,0	3,6	9,3	6,9	12,7	10,2	15,9	13,5	19,3	16,9	22,6	20,2	6,4	4,0
	S 08			8,0	5,0	11,3	8,1	14,7	11,4	18,0	14,7	21,3	18,1	8,5	5,3
	S 10					10,0	6,0	13,3	9,3	16,7	12,6	20,0	16,0	10,6	6,6
	S 12 ¹⁾							12,0	7,2	15,3	10,5	18,7	13,8	12,8	7,9
IA100	S 06	10,9	7,5	16,8	13,3	22,7	19,2	28,5	25,1	34,4	30,9	40,2	36,8	10,1	6,7
	S 08			14,6	10,0	20,4	15,8	26,3	21,7	32,2	27,5	38,0	33,4	13,5	8,9
	S 10					18,2	12,4	24,1	18,3	29,9	24,2	35,8	30,0	16,9	11,1
	S 12 ¹⁾							21,9	14,9	27,7	20,8	33,6	26,7	20,2	13,3
IA200	S 06	21,6	14,1	33,3	25,8	44,9	37,4	56,5	49,0	68,2	60,7	79,8	72,3	21	13,3
	S 08			28,8	18,8	40,5	30,5	52,1	42,1	63,7	53,7	75,4	65,4	27,7	17,7
	S 10					36,1	23,6	47,7	35,2	59,3	46,8	71,0	58,5	34,6	22,1
	S 12 ¹⁾							43,3	28,3	54,9	39,9	66,5	51,5	41,5	26,5
IA250	S 06	32,9	20,3	51,2	38,6	69,5	56,9	87,8	75,2	106,1	93,5	124,4	111,8	34,7	22,0
	S 08			43,9	27,0	62,2	45,3	80,5	63,6	98,8	81,9	117	100	46,2	29,3
	S 10					54,8	33,8	73,1	52,1	91,5	70,4	110	88,7	57,8	36,7
	S 12 ¹⁾							65,8	40,5	84,1	58,8	102	77,1	69,3	44,0
IA300	S 06	49,4	32,5	76,0	59,1	103	86	129	112	156	139	182	165	47,3	30,4
	S 08			65,8	43,3	92,4	69,9	119,0	96,5	146	123	172	150	63	40,5
	S 10					82,3	54,2	109	80,8	135	107	162	134	78,8	50,7
	S 12 ¹⁾							99	65	125	92	152	118	94,5	60,8
IA350	S 06	79,7	50,3	123	93,3	166	136	209	179	252	222	295	265	78,6	49,2
	S 08			106	67,1	149	110	192	153	235	196	278	239	105	65,6
	S 10					133	83,9	176	127	219	170	262	213	131	82,0
	S 12 ¹⁾							159	101	202	144	245	187	157	98,4
IA400	S 06	103	67,3	159	123	214	178	269	233	325	289	380	344	99	63,0
	S 08			138	89,7	193	145	248	201	304	256	359	311	132	84,0
	S 10					172	112	227	168	283	223	338	278	165	105
	S 12 ¹⁾							206	135	262	190	317	245	198	126
IA450	S 06	162	106	249	193	336	280	423	367	510	454	597	541	155	98,8
	S 08			216	142	303	229	390	316	477	403	564	490	206	132
	S 10					270	177	357	264	444	351	531	438	258	165
	S 12 ¹⁾							324	213	411	299	498	386	309	198
IA500	S 06	206	141	319	255	433	368	546	481	660	595	773	708	199	135
	S 08			274	188	388	302	501	415	615	528	728	642	266	180
	S 10					343	235	456	349	570	462	683	575	332	224
	S 12 ¹⁾							411	282	525	396	638	509	399	269
IA550	S 06	270	175	423	329	576	482							284	190
	S 08			360	234	513	387	666	540	819	693			379	253
	S 10					450	292	603	445	756	599	909	752	474	316
	S 12 ¹⁾							540	351	693	504	846	657	568	379
IA600	S 06	383	260	596	473	808	686							378	255
	S 08			511	347	723	560	936	772	1149	985			504	340
	S 10					638	434	851	646	1064	859	1277	1072	630	425
	S 12							766	520	979	733	1192	946	756	510
IA650	S 06	640	447	997	804	1354	1162							625	433
	S 08			853	596	1210	953	1568	1310	1925	1668			834	577
	S 10					1066	745	1423	1102	1781	1459	2138	1817	1042	721
	S 12							1279	894	1637	1251	1994	1608	1251	865
IA700	S 06	902	595	1420	1114	1939	1632							961	655
	S 08			1202	793	1721	1312	2239	1831	2758	2350			1281	873
	S 10					1503	992	2021	1510	2540	2029	3059	2548	1602	1091
	S 12							1803	1190	2322	1709	2840	2228	1922	1309
IA750	S 06	1277	844	1995	1562	2713	2280							1310	877
	S 08			1702	1125	2420	1843	3138	2561	3856	3279			1746	1170
	S 10					2128	1407	2846	2125	3564	2843	4282	3560	2183	1462
	S 12							2553	1688	3271	2406	3989	3124	2620	1754
IA800	S 06	1599	1217	2500	2118	3401	3019							1486	1104
	S 08			2132	1623	3033	2524	3934	3424	4835	4325			1981	1472
	S 10					2665	2028	3566	2929	4467	3830	5386	4731	2476	1839
	S 12							3198	2434	4099	3335	5000	4236	2971	2207
IA1000	S 06	2969	2034	4637	3701	6305	5369							2970	2034
	S 08			3959	2711	5627	4379	7294	6047	8962	7715			3960	2712
	S 10					4949	3389	6616	5057	8284	6725	9952	8393	4949	3390
	S 12							5938	4067	7606	5735	9274	7403	5939	4068

1) IA045 S33, IA050 - IA550. S12 = Standard version of InterApp. Other number of springs on request

Dimensions

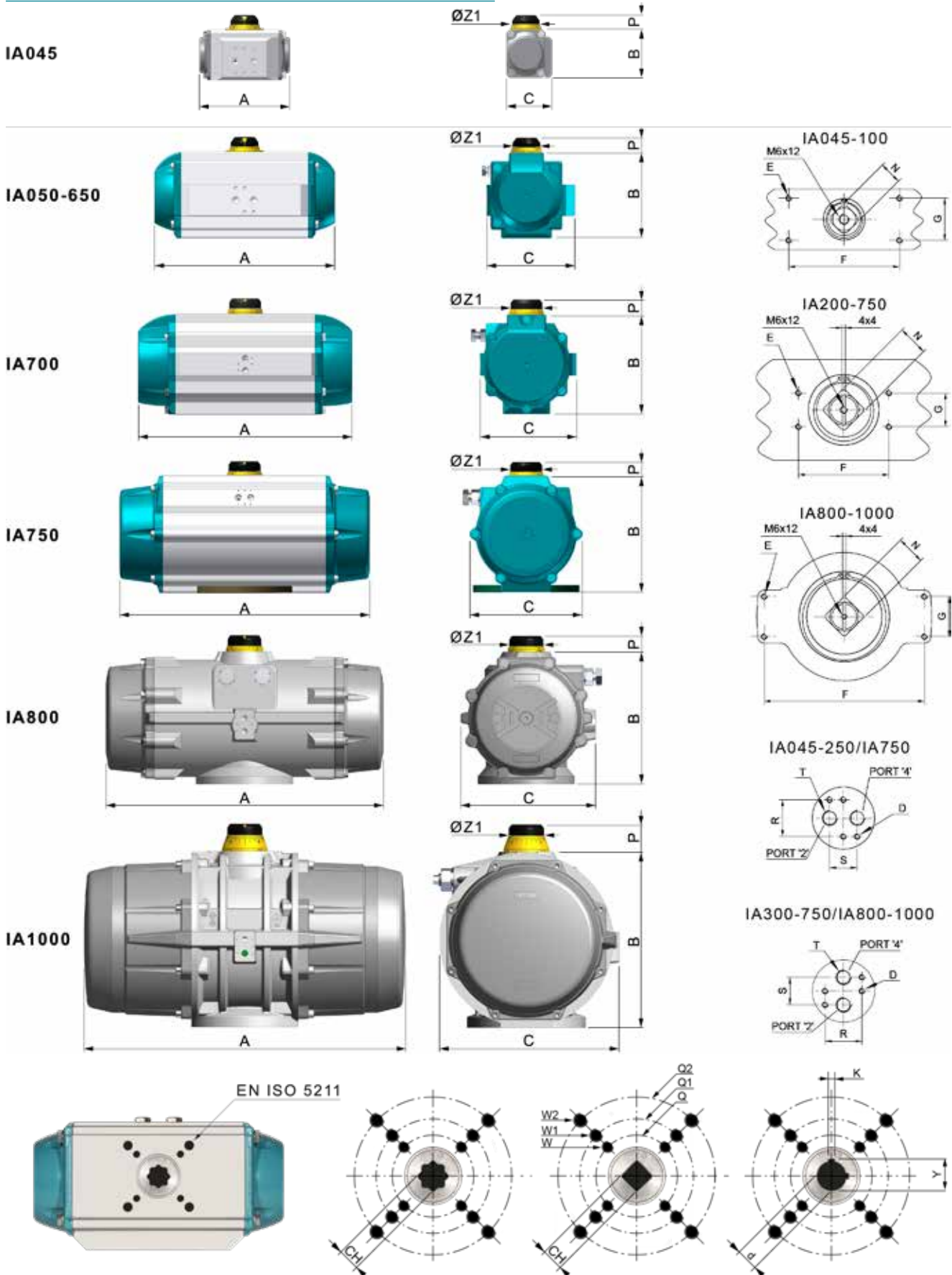

Dimensions

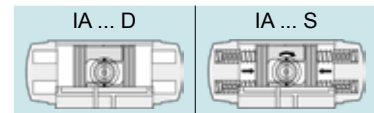

	A	B	C	D	E	F	G	N	P	R	S	T ¹⁾	Z1	V _o [l]	V _c [l]	t _o "	t _c "	[kg]	t _o "	t _c "	[kg]
IA 045	118	66	62	M5x8	M5x8	80	30	11	20	32	24	1/8"	37	0,06	0,1	0,15	0,20	0,75	0,20	0,25	0,9
IA 050	137	69	78,5	M5x8	M5x8	80	30	11	20	32	24	1/8"	42	0,09	0,15	0,2	0,25	1,15	0,25	0,3	1,26
IA 100	154	85	91,5	M5x8	M5x8	80	30	11	20	32	24	1/8"	42	0,16	0,26	0,25	0,3	1,7	0,3	0,35	1,9
IA 200	204	102	105	M5x8	M5x8	80	30	17	20	32	24	1/8"	42	0,31	0,49	0,3	0,35	3,0	0,4	0,5	3,4
IA 250	241	115	118,5	M5x8	M5x8	80	30	17	20	32	24	1/8"	42	0,51	0,78	0,4	0,5	4,2	0,5	0,6	4,8
IA 300	259	127	130,5	M5x8	M5x8	80	30	17	20	32	24	1/4"	42	0,71	1,11	0,5	0,6	5,7	0,7	0,9	6,6
IA 350	304	145	148,5	M5x8	M5x8	80	30	27	30	32	24	1/4"	58	1,19	1,80	0,7	0,8	8,8	0,9	1,1	10,2
IA 400	333	157	159	M5x8	M5x8	80	30	27	30	32	24	1/4"	58	1,54	2,34	0,9	1,1	10,7	1,2	1,4	12,6
IA 450	395	177	182,5	M5x8	M5x8	80	30	27	30	32	24	1/4"	67,5	2,41	3,78	1,2	1,4	15,5	1,5	1,8	18,7
IA 500	423	196	200,5	M5x8	M5x8	80	30	27	30	32	24	1/4"	67,5	3,14	4,92	1,5	1,7	19,6	1,8	2,1	23,7
IA 550	473	221	223	M5x8	M5x8	130	30	36	50	32	24	1/4"	80	4,26	6,89	2	2,2	25	2,4	2,8	33
IA 600	528	245	244,5	M5x8	M5x8	130	30	36	50	32	24	1/4"	80	5,94	9,46	2,7	3,2	37	3,5	4	45
IA 650	605	299	284	M6x10	M5x8	130	30	36	50	45	40	3/8"	115	10,0	15,2	3,5	4	56	4,1	4,6	71
IA 700	710	330	319	M6x10	M5x8	130	30	36	50	45	40	1/2"	115	14,5	21,4	4	4,5	77	4,5	5	97
IA 750	812	383	371	M6x10	M5x8	130	30	36	50	45	40	1/2"	115	20	33	5	6	118	6	7	150
IA 800	876	410	418	M6x10	M5x8	130	30	36	50	45	40	1/2"	115	25	40	6	7	127	7,5	8,5	169
IA 1000	950	518	528	M6x10	M6x10	200	50	36	80	45	40	1/2"	135	49	84	8	9	170	10	11	238

1) BSP / ISO 228 / DIN 259

V(l) Volume in litre, V_o = OPEN, V_c = CLOSE

To calculate the air consumption, multiply the volume in litre by the supply pressure.

t_o / t_c t_o = opening time / t_c = closing time, in seconds

The above mentioned operating times are obtained under the following conditions:

- Air supply pressure min. 5,5 bar (80 psi) - at room temperature - medium clean air - actuator stroke 90° - actuator without resistance load

Caution: obviously, during operation, if one or more of the above listed criteria differ, the operating time will be different.

	EN ISO 5211	Q	Q1	Q2	W	W1	W2	CH* x l	CH♦ x l	d● x l	K	Y	
IA 045	F03	36	-	-	M5	-	-	9 x 11	-	-	-	-	
	F04	42	-	-	M5	-	-	11 x 12	-	-	-	-	
IA 050	F03-F05	36	50	-	M5	M6	-	9 x 11	-	-	-	-	
	F04	42	-	-	M5	-	-	11 x 12	-	-	-	-	
IA 100	F04	42	-	-	M5	-	-	11 x 19	-	-	-	-	
	F05-F07	50	70	-	M6	M8	-	11 x 19	-	-	-	-	
IA 200	F05-F07	50	70	-	M6	M8	-	14 x 16	-	-	-	-	
IA 250	F05-F07	50	70	-	M6	M8	-	14 x 19	11 x 19	-	-	-	
IA 300	F05-F07-F10	50	70	102	M6	M8	M10	17 x 19	14 x 19	-	-	-	
IA 350	F07-F10	70	102	-	M8	M10	-	22 x 25	-	-	-	-	
IA 400	F07-F10	70	102	-	M8	M10	-	17 x 25	14 x 19	-	-	-	
IA 450	F10-F12	102	125	-	M10	M12	-	22 x 32	-	-	-	-	
IA 500	F10-F12	102	125	-	M10	M12	-	27 x 40	17 x 25	-	-	-	
IA 550	F14	140	-	-	M16	-	-	22 x 40	22 x 40	-	-	-	
IA 600	F10-F12	102	125	-	M10	M12	-	36 x 38	-	-	-	-	
	F14	140	-	-	M16	-	-	27 x 40	22 x 40	-	-	-	
IA 650	F12	125	-	-	M12	-	-	-	d45 x 65	14	49		
	F14	140	-	-	M16	-	-	-	22 x 40	-	-	-	
IA 700	F12	125	-	-	M12	-	-	27 x 40	27 x 40	-	-	-	
	F14	140	-	-	M16	-	-	-	d45 x 65	14	49		
IA 750	F16	165	-	-	M20	-	-	-	d65 x 80	18	69,5		
	F14	140	-	-	M16	-	-	-	d45 x 80	14	49		
IA 800	F16	165	-	-	M20	-	-	27 x 70	d60 x 115	18	64,5		
	F16-F25	165	254	-	M20	M16 (8x)	-	46 x 49	d70 x 130	20	75		
IA 1000	F16-F25-F30	165	254	298	M20	M16 (8x)	M20 (8x)	55 x 59	75 x 80	-	d45 x 65	14	49
											d60 x 80	18	64,5
											d65 x 80	18	69,5
											d70 x 80	20	75

Accessories

Our wide range of accessories includes all kinds of position indicators, solenoid valves, positioners, Bus systems, manual emergency overdrives, etc. Please refer to the corresponding documentation or download it from our website.



Limit switches



Proximity switch
AS-Interface



Positioner



Solenoid valve

Actuator size, solenoid valve and air supply pipe according table below.

Actuator size	Solenoid valve	Air supply pipe
IA045 - 350	≥ DN 4	≥ DN 4
IA400 - 600	≥ DN 7	≥ DN 6
IA650 - 700	≥ DN 12	≥ DN 8
IA750 - 1000	≥ DN 12	≥ DN 10