

4A100 Series



Specification

Model	4A110-M5 4A120-M5	4A130C-M5 4A130E-M5 4A130P-M5	4A110-06 4A120-06	4A130C-06 4A130E-06 4A130P-06
Fluid	Air(to be filtered by 40 μm filter element)			
Acting	Exterior control			
Port size ①	In=Out=M5		In=Out=1/8"	
Orifice size	5.5mm ² (Cv=0.31)	5.0mm ² (Cv=0.28)	12.0mm ² (Cv=0.67)	9.0mm ² (Cv=0.50)
Valve type	5 port 2 position	5 port 3 position	5 port 2 position	5 port 3 position
Operating pressure	0.15~0.8MPa(21~114psi)			
Proof pressure	1.5MPa(215psi)			
Temperature °C	-20~70			
Material of body	Aluminum alloy			
Lubrication ②	Not required			
Max. frequency ③	5 cycle/sec	3 cycle/sec	5 cycle/sec	3 cycle/sec
Weight (g)	4A110-M5:85 4A120-M5:140	165	4A110-06:85 4A120-06:140	165

- ① G thread and NPT thread are available.
- ② Once lubricated air is used, continue with same medium to optimise valve life span. Lubricants like ISO VG32 or equivalent are recommended.
- ③ The maximum actuation frequency of no-load state.

Symbol

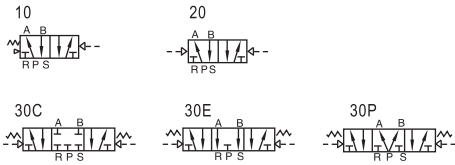

Product feature

- Structure in sliding column mode: good tightness and sensitive reaction.
- Three position air valves have three kinds of central function for your choice.
- Double air control valves have memory function.
- Internal hole adopts special processing technology which has little attrition friction, low start pressure and long service life.
- No need to add oil for lubrication.
- Integrate with the manifold to save installation space.

Ordering code

4A 1 10 06 G

- Model: 4A: Air Valve(5/2, 5/3 way)
- Code: 1: 100 Series
- Valve type:

10: Single air control 5/2 way
20: Double air control 5/2 way
30C: Double air control 5/3 way closed center
30E: Double air control 5/3 way exhaust center
30P: Double air control 5/3 way pressure center
- Thread type:

Port size	Thread type
1/8"	G: G
M5	T: NPT
	No this code
- Port size:

M5: M5
06: 1/8"

Flow chart

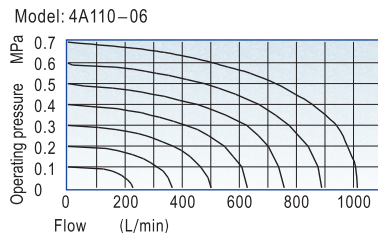
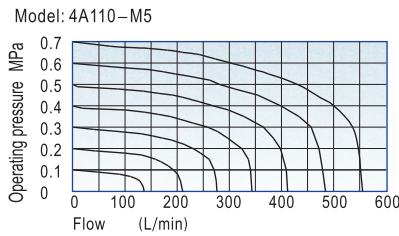

Please refer to 64 for manifold specification and the order way.

Air valve(5/2 way, 5/3 way)

4A100 Series

Inner structure

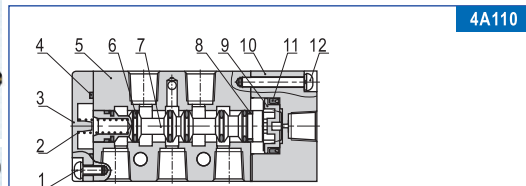

4A110

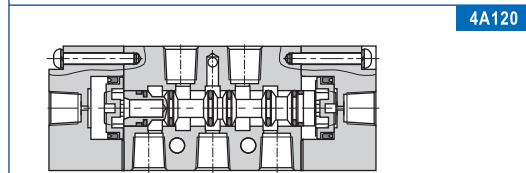

4A120

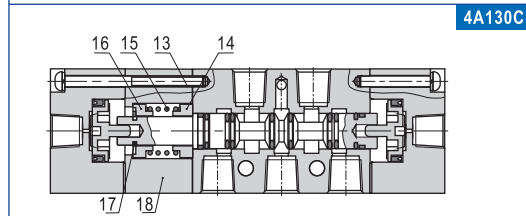

4A130C

No.	Item	No.	Item	No.	Item
1	Screw	7	Spool	13	Screw
2	Spring	8	Wear ring	14	Spring holder
3	Bottom cover	9	Piston	15	Return Spring
4	Bottom cover gasket	10	Pilot body	16	Spring holder
5	Body	11	O-ring	17	E Clip
6	O-ring	12	Screw	18	Side cover

Dimension

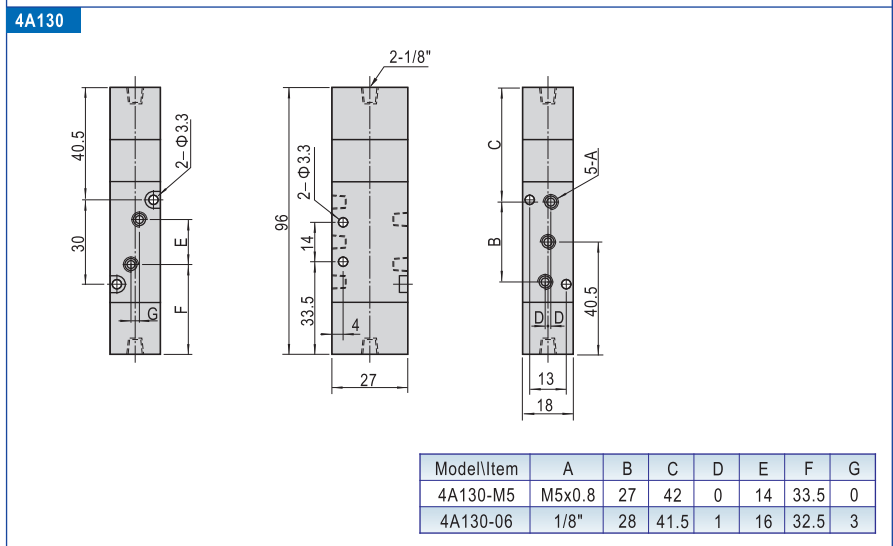
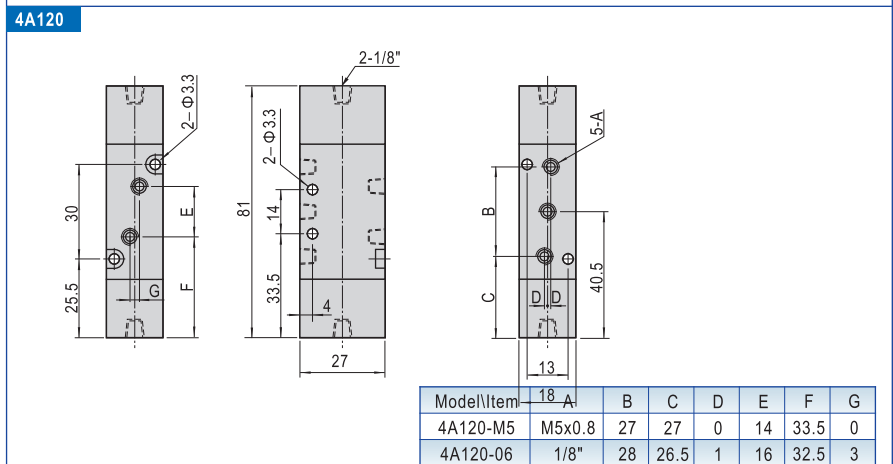
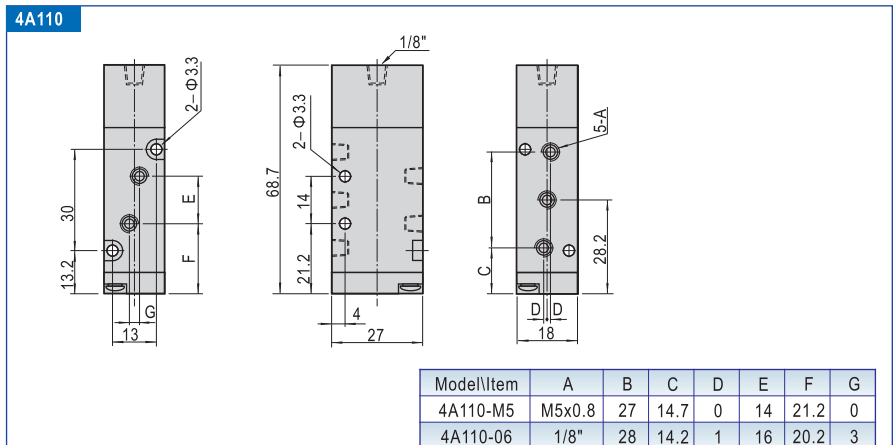

Air valve(5/2 way, 5/3 way)

4A200 Series



Symbol

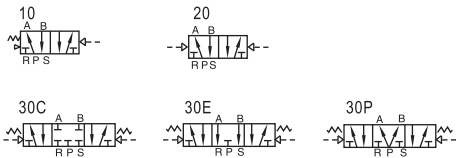

Product feature

1. Structure in sliding column mode: good tightness and sensitive reaction.
2. Three position air valves have three kinds of central function for your choice.
3. Double air control valves have memory function.
4. Internal hole adopts special processing technology which has little attrition friction, low start pressure and long service life.
5. No need to add oil for lubrication.
6. Integrate with the manifold to save installation space.

Flow chart

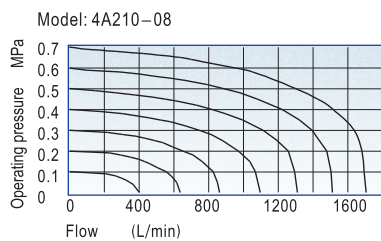
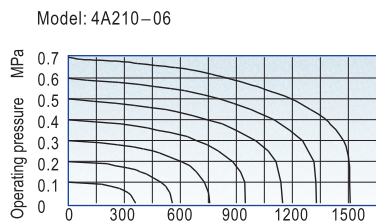

Specification

Model	4A210-06 4A220-06	4A230C-06 4A230E-06 4A230P-06	4A210-08 4A220-08	4A230C-08 4A230E-08 4A230P-08
Fluid	Air(to be filtered by 40 μ m filter element)			
Acting	Exterior control			
Port size ①	In=Out=Exhaust=1/8"		In=Out=1/4" Exhaust=1/8"	
Orifice size	14.0mm ² (Cv=0.78)	12.0mm ² (Cv=0.67)	16.0mm ² (Cv=0.89)	12.0mm ² (Cv=0.67)
Valve type	5 port 2 position	5 port 3 position	5 port 2 position	5 port 3 position
Operating pressure	0.15~0.8MPa(21~114psi)			
Proof pressure	1.5MPa(215psi)			
Temperature °C	-20~70			
Material of body	Aluminum alloy			
Lubrication ②	Not required			
Max. frequency ③	5 cycle/sec	3 cycle/sec	5 cycle/sec	3 cycle/sec
Weight (g)	4A210-06:185 4A220-06:285	365	4A210-08:185 4A220-08:285	365

- ① G thread and NPT thread are available.
- ② Once lubricated air is used, continue with same medium to optimise valve life span. Lubricants like ISO VG32 or equivalent are recommended.
- ③ The maximum actuation frequency of no-load state.

Ordering code

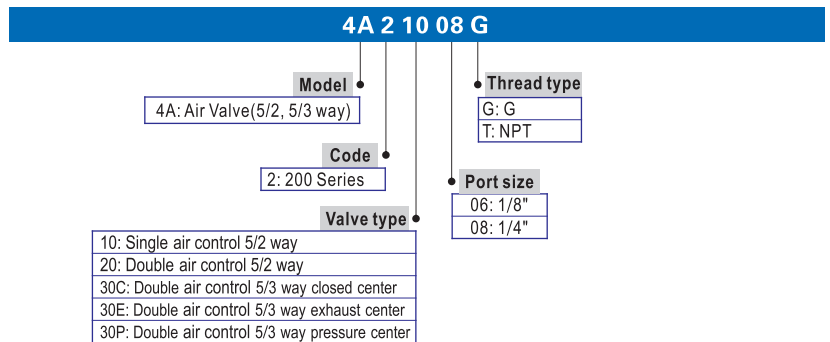

Please refer to 64 for manifold specification and the order way.

Air valve(5/2 way, 5/3 way)

4A200 Series

Inner structure

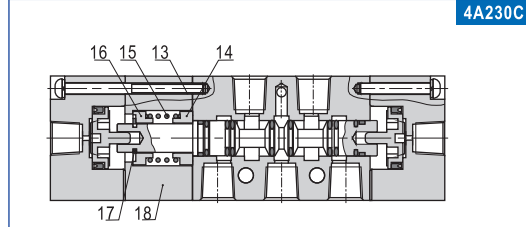
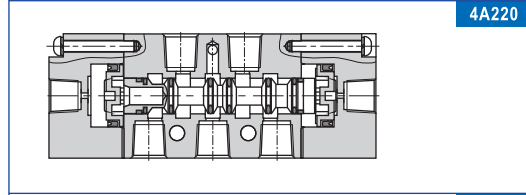
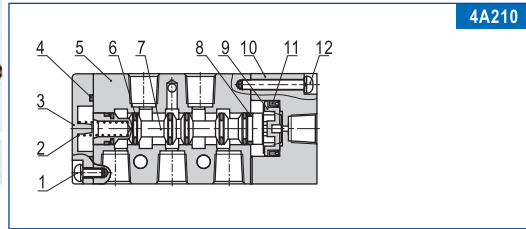

No.	Item	No.	Item	No.	Item
1	Screw	7	Spool	13	Screw
2	Spring	8	Wear ring	14	Spring holder
3	Bottom cover	9	Piston	15	Return Spring
4	Bottom cover gasket	10	Pilot body	16	Spring holder
5	Body	11	O-ring	17	E Clip
6	O-ring	12	Screw	18	Side cover

Dimension

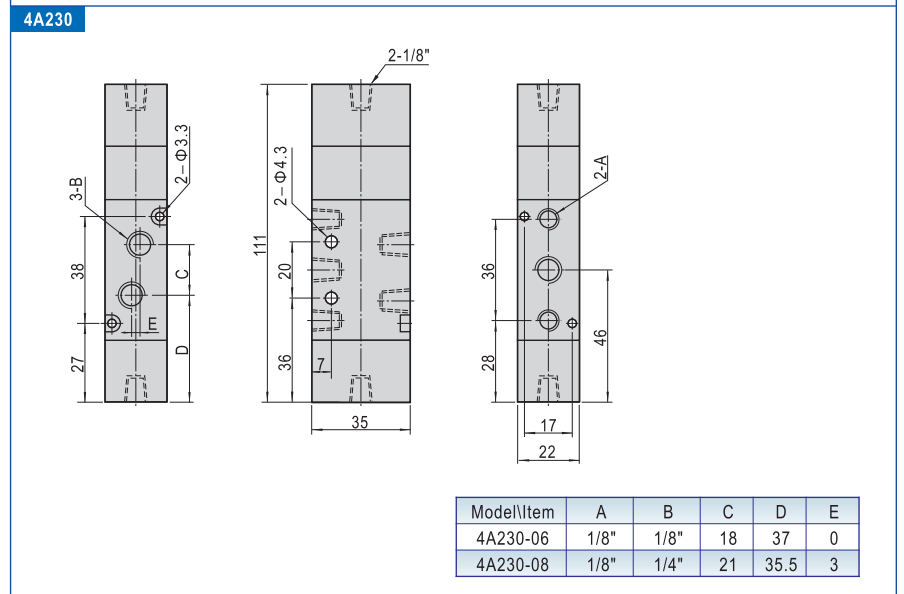
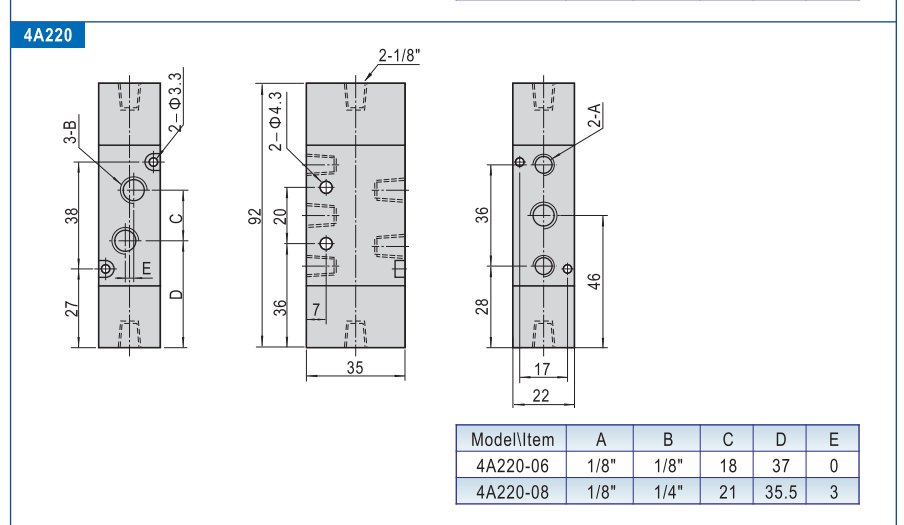
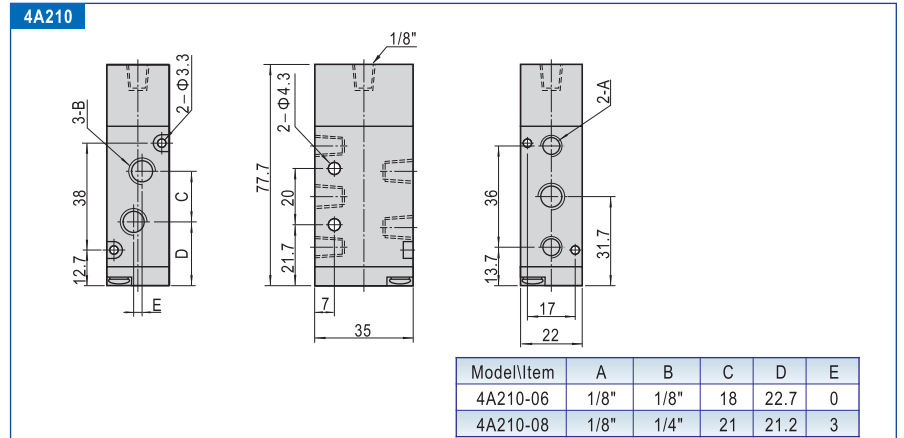

Air valve(5/2 way, 5/3 way)

4A300 Series



Symbol

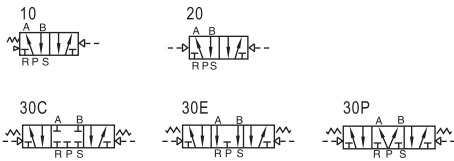

Product feature

1. Structure in sliding column mode: good tightness and sensitive reaction.
2. Three position air valves have three kinds of central function for your choice.
3. Double air control valves have memory function.
4. Internal hole adopts special processing technology which has little attrition friction, low start pressure and long service life.
5. No need to add oil for lubrication.
6. Integrate with the manifold to save installation space.

Flow chart

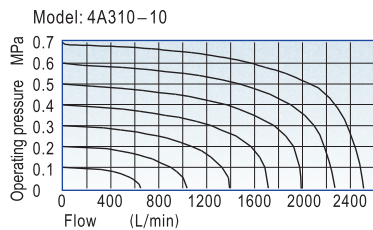
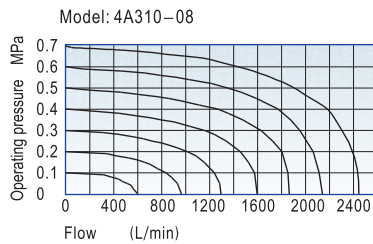

Specification

Model	4A310-08 4A320-08	4A330C-08 4A330E-08 4A330P-08	4A310-10 4A320-10	4A330C-10 4A330E-10 4A330P-10
Fluid	Air(to be filtered by 40 μm filter element)			
Acting	Exterior control			
Port size ①	In=Out=Exhaust=1/4"		In=Out=3/8" Exhaust=1/4"	
Orifice size	25.0mm ² (Cv=1.40)	18.0mm ² (Cv=1.00)	30.0mm ² (Cv=1.68)	18.0mm ² (Cv=1.00)
Valve type	5 port 2 position	5 port 3 position	5 port 2 position	5 port 3 position
Operating pressure	0.15~0.8MPa(21~114psi)			
Proof pressure	1.5MPa(215psi)			
Temperature °C	-20~70			
Material of body	Aluminum alloy			
Lubrication ②	Not required			
Max. frequency ③	4 cycle/sec	3 cycle/sec	4 cycle/sec	3 cycle/sec
Weight (g)	4A310-08:275 4A320-08:365	505	4A310-10:275 4A320-10:365	505

- ① G thread and NPT thread are available.
- ② Once lubricated air is used, continue with same medium to optimise valve life span. Lubricants like ISO VG32 or equivalent are recommended.
- ③ The maximum actuation frequency of no-load state.

Ordering code

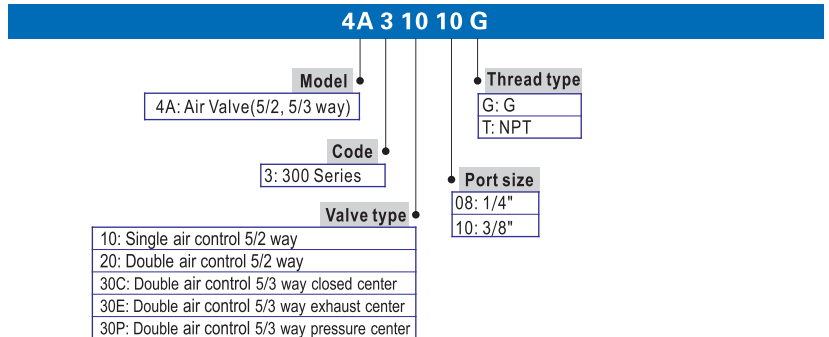

Please refer to 64 for manifold specification and the order way.

Air valve(5/2 way, 5/3 way)

4A300 Series

Inner structure

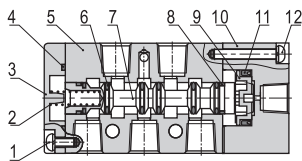

4A310

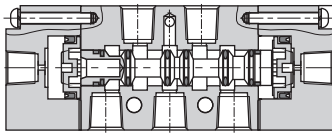

4A320

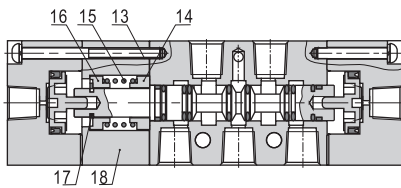

4A330C

No.	Item	No.	Item	No.	Item
1	Screw	7	Spool	13	Screw
2	Spring	8	Wear ring	14	Spring holder
3	Bottom cover	9	Piston	15	Return Spring
4	Bottom cover gasket	10	Pilot body	16	Spring holder
5	Body	11	O-ring	17	E Clip
6	O-ring	12	Screw	18	Side cover

Dimension

4A310

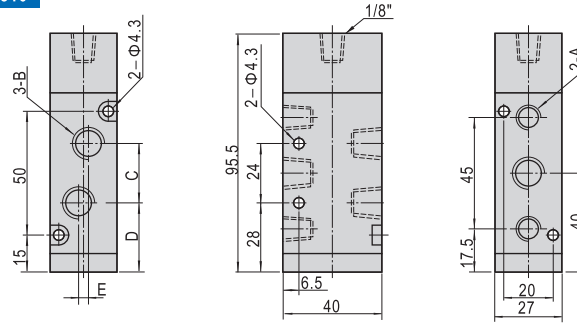

Model\Item	A	B	C	D	E
4A310-08	1/4"	1/4"	22	29	0
4A310-10	1/4"	3/8"	24	28	4

4A320

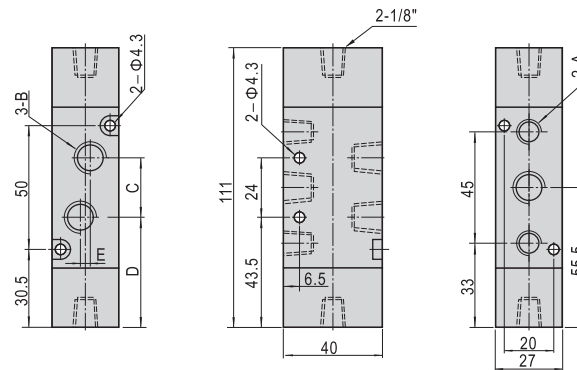

Model\Item	A	B	C	D	E
4A320-08	1/4"	1/4"	22	44.5	0
4A320-10	1/4"	3/8"	24	43.5	4

4A330

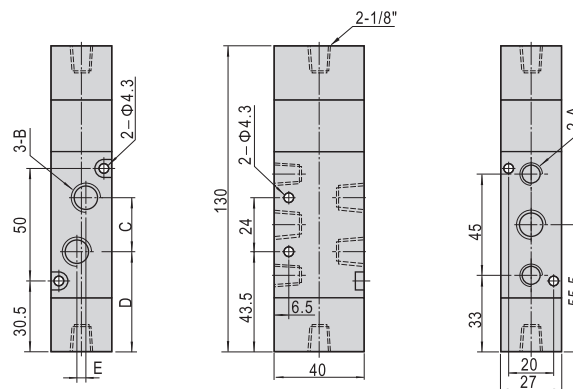

Model\Item	A	B	C	D	E
4A330-08	1/4"	1/4"	22	44.5	0
4A330-10	1/4"	3/8"	24	43.5	4

Air valve(5/2 way, 5/3 way)

4A400 Series

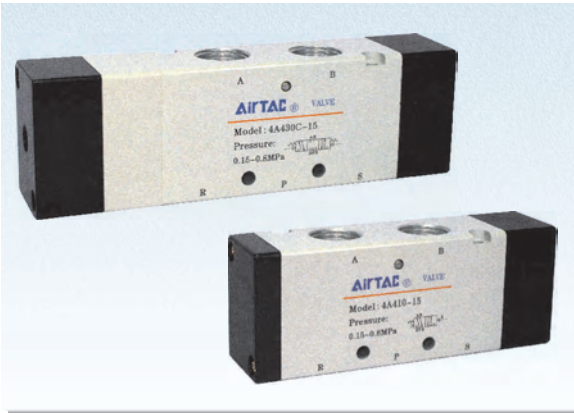

Symbol

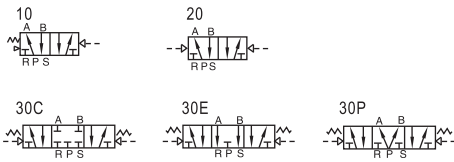

Product feature

1. Structure in sliding column mode: good tightness and sensitive reaction.
2. Three position air valves have three kinds of central function for your choice.
3. Double air control valves have memory function.
4. Internal hole adopts special processing technology which has little attrition friction, low start pressure and long service life.
5. No need to add oil for lubrication.
6. Integrate with the manifold to save installation space.

Flow chart

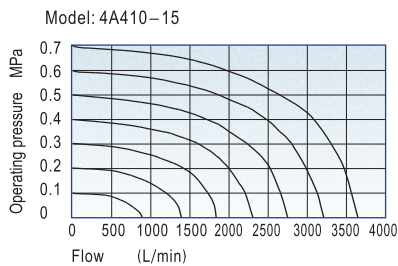

Specification

Model	4A410-15	4A420-15	4A430C-15	4A430E-15	4A430P-15
Fluid	Air(to be filtered by 40 μ m filter element)				
Acting	Exterior control				
Port size ①	In=Out=Exhaust=1/2"				
Orifice size	50.0mm ² (Cv=2.79)		30.0mm ² (Cv=1.68)		
Valve type	5 port 2 position		5 port 3 position		
Operating pressure	0.15~0.8MPa(21~114psi)				
Proof pressure	1.5MPa(215psi)				
Temperature °C	-20~70				
Material of body	Aluminum alloy				
Lubrication ②	Not required				
Max. frequency ③	3 cycle/sec				
Weight (g)	555	685			735

- ① G thread and NPT thread are available.
- ② Once lubricated air is used, continue with same medium to optimise valve life span. Lubricants like ISO VG32 or equivalent are recommended.
- ③ The maximum actuation frequency of no-load state.

Ordering code

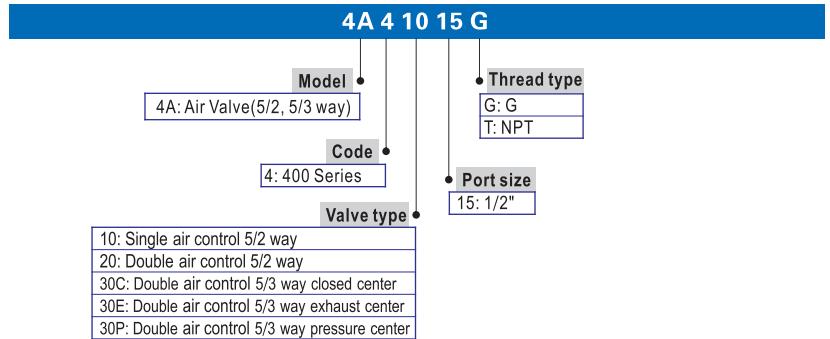

Please refer to 64 for manifold specification and the order way.

4A400

Air valve(5/2 way, 5/3 way)

4A400 Series

Inner structure

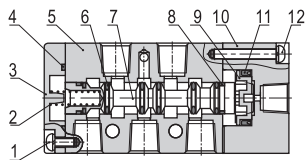

4A410

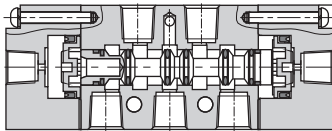

4A420

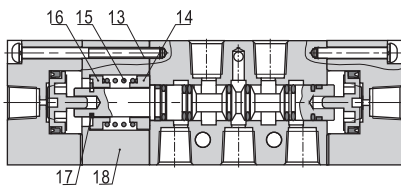

4A430C

No.	Item	No.	Item	No.	Item
1	Screw	7	Spool	13	Screw
2	Spring	8	Wear ring	14	Spring holder
3	Bottom cover	9	Piston	15	Return Spring
4	Bottom cover gasket	10	Pilot body	16	Spring holder
5	Body	11	O-ring	17	E Clip
6	O-ring	12	Screw	18	Side cover

Dimension

4A410

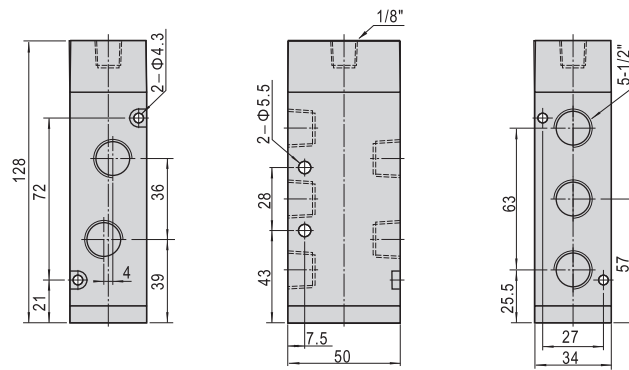

4A420

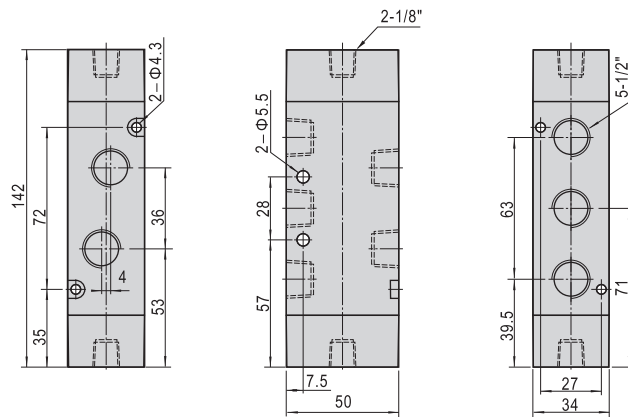

4A430

