

# special worldwide 2013 Industrial and Automotive



Valid until February 28, 2014



For Smartphones  
with QR-Reader (App)  
PDF Download of the  
SWW 2013



*The tool brand which stands for competence in production  
and development of quality tools – since 145 years!*





Assistant® 177-6/130

130



130 expert tools!



161-26P/18 s 6 – 27 mm

161-54P/4



161-49P/28 <sup>122</sup> 1/2  
⊕ s 12 – 32 mm  
⊗ s 8 – 30 mm

161-50P/30  
⊕ 3/4 ⊖ 1/2 ⊕ ⊗  
○ s 4 – 14 mm

161-24P/8



2240/36

⊕ ⊗ ⊕ ⊗ ⊕ ⊗



810SPC/6

⊕ ⊗

## HAZET-Cockpit

The third dimension for the Assistant®

- Attachable and portable Tool Box "Cockpit"
- Suitable for Assistant® 178, 179 and 180
- approx. 14 kg (incl. tools)



70

2 x			
1 x			
1 x			
13 x		600 N-7 8 9 10 11 12 13 14 15 16 17 18 19 mm	
12 x		s 4 5 5.5 6 7 8 9 10 11 12 13 14 mm	
5 x		3 4 5 6 8 mm	
2 x		PZ 1 PZ 2	
1 x			
1 x			
2 x		55 147 mm	
1 x			
16 x		s 10 11 12 13 14 15 16 17 18 19 20 21 22 24 27 30 mm	
1 x			
2 x		123 248 mm	
1 x			
3 x		0.8 x 4.0 x 100 mm 1.0 x 5.5 x 125 mm 1.2 x 6.5 x 150 mm	
2 x		PH 1 PH 2	
4 x		T20H T25H T27H T30H	

HAZET No.	Description
190-20/70	HAZET-Cockpit with 70 Pc. Tool Assortment
190-20	HAZET-Cockpit with insert, without assortment, empty
190-20-1	Cockpit retaining plate (right), with accessories for Tool Trolley Assistant® 178, 179
190-20-2	Cockpit retaining plate (rear), with accessories for Assistant® 179
190-20-3	Cockpit retaining plate (right), with accessories for Tool Trolley Assistant® 180, also usable with Tool Box 180 K-4

### Plastic Tote Tray 190 L-1

Made in Germany

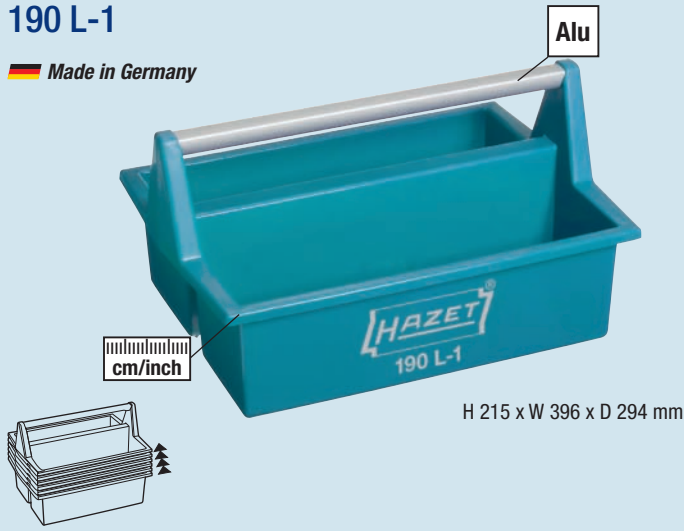

H 215 x W 396 x D 294 mm

### Metal Tool Box, empty 190 L



H 200 x W 530 x D 200 mm

### Plastic Tool Box 190 L-2

Made in Germany



H 270 x W 550 x D 250 mm

HAZET No.	Description
190 L-2	2 Boxes for small parts H 215 x W 470 x D 250 mm
190 L-3	3 Boxes for small parts H 270 x W 550 x D 250 mm

## Table of Contents



### General Workshop Equipment

- Tool Trolley with Assortment, Accessories from page 2 on
- Tool Boxes from page 2 on
- Tool Trolleys *Assistant* from page 12 on
- Tool Assortments from page 15 on

from page 2 on



### Hand Tools

- Socket Sets, Reversible Ratchets page 20
- Wrenches, Screwdrivers from page 20 on
- Sockets page 22
- Screwdriver Bits page 23
- Pliers, Drift Pins, Thread Repair page 24
- Tool Set for Hybrid and Electric Vehicles page 24
- Pullers / Extractors page 25

from page 20 on



### Torque Technology

- SYSTEM 5000 CT page 26
- SYSTEM 7000 eTAC page 26
- Torque Multiplier page 27
- Torque Screwdriver page 27
- Insert Tools page 27

from page 26 on



### Pneumatic Tools / Machinery

- Impact Wrenches, Air Ratchets from page 28 on
- Air Drill, Grinder page 30
- Polisher, Saw, Scaler, Chisel, Blind Rivet Gun page 31
- Air Blow and Suction Guns, Tire Inflator page 32
- Cordless Tools, Hot Air Tool page 33
- Spiral Hose page 33

from page 28 on



### Workshop Tools

- HAZET Fashion Collection page 34
- Covers, Gloves, Lights, Creepers etc. from page 34 on
- Bowls, Funnels, Measuring Cups etc. page 37
- Spraying Machines, Grease Guns etc. from page 38 on
- Cutters, Safety Glasses, Hearing Protection page 40

from page 34 on



### Specialty Tools

- Engine from page 41 on
- Brakes from page 45 on
- Exhaust, Clutch page 46
- Chassis from page 47 on
- Borescopes / Inspection page 57

from page 41 on



### Commercial Vehicles / Industry

- General Workshop Equipment page 2
- Hand Tools from page 3 on
- Torque Technology page 4
- Pneumatic Tools / Machinery page 5
- Workshop Tools page 5
- Specialty Tools from page 6 on

see last page



Number of pieces in insert  
or assortment



**Safety-Insert-System**  
in 2-component soft foam insert  
(suitable for HAZET-*Assistant*)



All rights reserved regarding technical modifications, figures may not always correspond to the original and are thus not binding! Errors and omissions excepted!



Work Bench 177 W-7/169

169 expert tools!

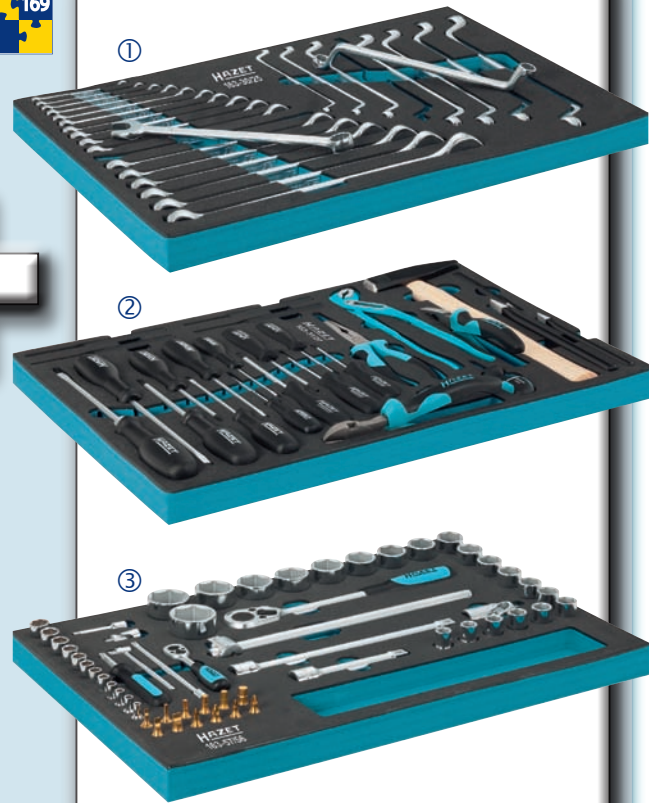





or

Assistent® 178-6/169

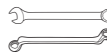
169 expert tools!



- ① Wrench Set 163-30/25, 25 pieces (3/3)  
 s 6 – 24 mm  
 s 6x7 – 21x22 mm
- ② Tool Set 163-31/27, 27 pieces (3/3)  

- ③ Socket Set 163-57/56, 56 pieces (3/3)  
 6.3 ¼ s 4 – 14 mm  12.9 ½ s 10 – 34 mm

Screwdriver Bit Set 2240/36, 36 pieces



Twist Drill Bits in Case 2128-1, 25 pieces  
Ø 1–13 mm

Assistant® 179-7/220

Assistant  
2-component Safety-Insert-System



**220 expert tools!**



①



②



③

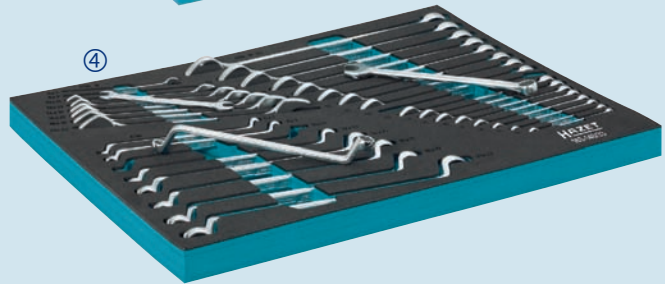

④



**Screwdriver Bit Set 2240/36, 36 pieces**

**Twist Drill Bits in Case 2128-1, 25 pieces**  
 Ø 1–13 mm

- ① **Screwdriver Set 163-141/31, 31 pieces** (3/3)
- ② **Universal Set 163-143/18, 18 pieces** (3/3)
- ③ **Socket Set 163-138/77, 77 pieces** (3/3)  

 1/4 s 4 – 14 mm    1/2 s 10 – 32 mm
- ④ **Wrench Set 163-140/33, 33 pieces** (3/3)  

 s 6x7 – 21 x 22 mm  
 s 6 – 24 mm  
 s 6x7 – 21 x 22 mm



Premium Workshop Equipment  
including the HAZET-Cockpit  
179-7/199



- ① Double Box-End Wrench Set 163-101/9, 9 pieces (2/3)  
s 6x7 – 21x23 mm
- ② TORX® Socket Set 163-192/24, 24 pieces (1/3)  
6.3 ¼ 12.9 ½ T8–T55 E5 – E20
- ③ T-Handle TORX® Screwdriver Set 163-182/9, 9 pieces (1/3)  
T6–T30
- ④ Hex Nut-Driver Set 163-122/3, 3 pieces (1/3)  
s 8, 10, 13 mm
- ⑤ T-Handle Screwdriver Set for inside hexagon screws 163-189/6, 6 pieces (1/3)  
s 2–6 mm
- ⑥ Socket Set 163-181/17, 17 pieces (1/3)  
10 3/8 s 10–22 mm



Screwdriver Bit Set  
2240/36, 36 pieces  
⊖ ⊕ ⊛ ⊜ ⊝ ⊞



Twist Drill Bits in Case  
2128-1, 25 pieces  
Ø 1–13 mm

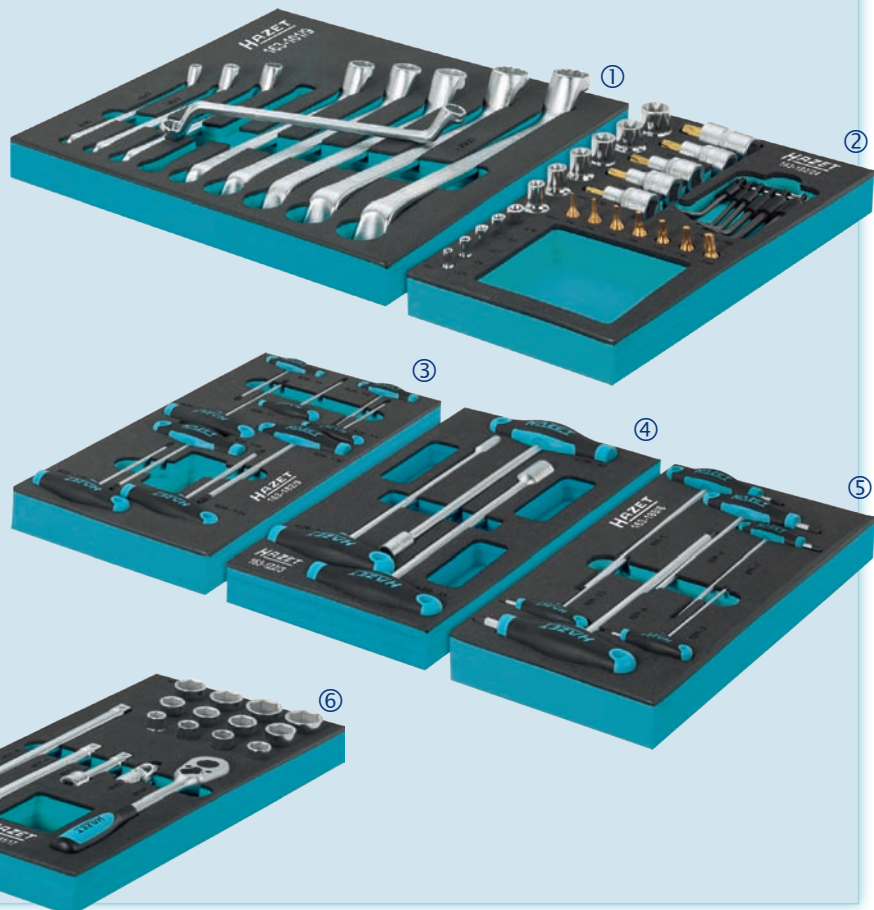

Assistant® 179XL-7/232

232 expert tools!



- ① Tool Set 163-141/31, 31 pieces (3/3)  
— ● ○ ○ ○
- ② Soft Foam Insert with Compartment for Small Pieces 163-172 x 50
- ③ Pliers Set 163-96/3, 3 pieces (1/3)
- ④ Socket Set 163-131/8 (3/3 extension)  

12 <sup>24</sup> 1/2 s 17 mm	12 <sup>24</sup> 1/2 s 19 mm	10 3/8 ⇌ 6.3 1/4	20 3/4 ⇌ 12 <sup>24</sup> 1/2
12 <sup>24</sup> 1/2 ⇌ 10 3/8	12 <sup>24</sup> 1/2 ⇌ 20 3/4	10 3/8 ⇌ 12 <sup>24</sup> 1/2	6.3 1/4 ⇌ 10 3/8
- ⑤ Tool Set 163-224/57, 57 pieces (2/3)  

6.3 1/4 s 5.5-13 mm	6.3 1/4 s 3-10 mm	12 <sup>24</sup> 1/2 s 10-32 mm
---------------------	-------------------	---------------------------------
- ⑥ Socket Set 163-181/17, 17 pieces (1/3)  
10 3/8 s 10-22 mm
- ⑦ TORX® Socket Set 163-192/24, 24 pieces (1/3)  
6.3 1/4 12<sup>24</sup> 1/2 T8-T55 E5-E20
- ⑧ Soft Foam Insert with Compartments for Small Pieces 163-522 x 50
- ⑨ Wrench Set 163-30/25, 25 pieces (3/3)  

○ s 6-24 mm	○ s 6x7-21x22 mm
-------------	------------------
- ⑩ Ratcheting Combination Wrench Set 163-97/6, 6 pieces (1/3)  

○ s 8, 10, 12, 13, 17, 19 mm
------------------------------



980 mm

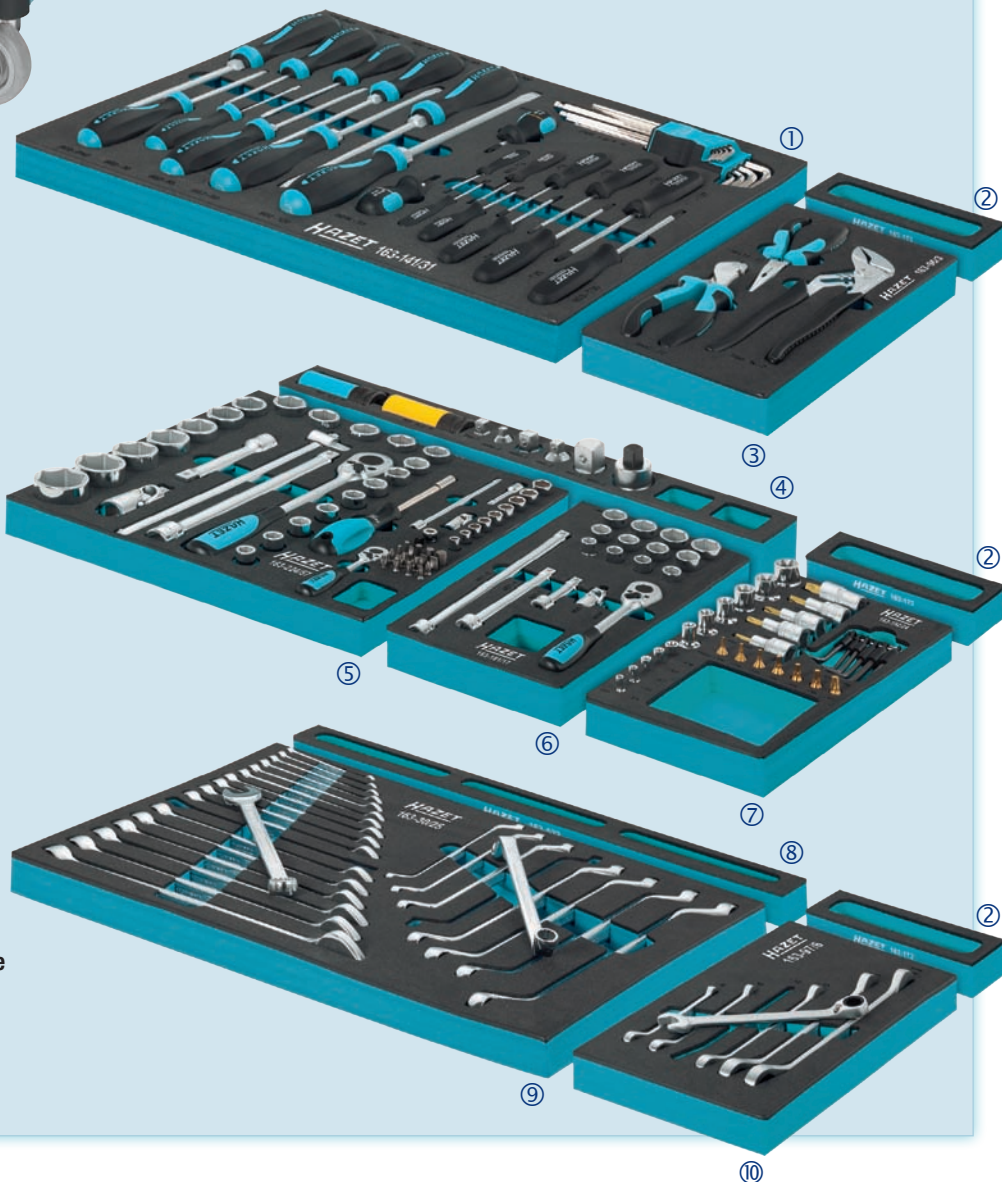

Screwdriver Bit Set  
2240/36, 36 pieces  
— ● ○ ○ ○ ○ ○



Twist Drill Bits in Case  
2128-1, 25 pieces  
∅ 1-13 mm



Assistant® 179 XXL-7/257

257 expert tools!



257



1155 mm

- ① **Socket Set 163-131/8** (3/3 extension)  

12.5 1/2 s 17 mm	12.5 1/2 s 19 mm	10 3/8	6.3 1/4	20 3/4	12.5 1/2
12.5 1/2	10 3/8	12.5 1/2	20 3/4	10 3/8	12.5 1/2
- ② **Soft Foam Insert with compartments for small pieces 163-172 x 50**
- ③ **Tool Set 163-224/57, 57 pieces** (2/3)  
 6.3 1/4 s 5.5-13 mm    6.3 1/4 s 3-10 mm    12.5 1/2 s 10-32 mm
- ④ **Socket Set 163-181/17, 17 pieces** (1/3)  
 10 3/8 s 10-22 mm
- ⑤ **TORX® Socket Set 163-192/24, 24 pieces** (1/3)  
 6.3 1/4    12.5 1/2    T8-T55    E5-E20
- ⑥ **XZN Screwdriver Socket Set 163-222/13, 13 pieces** (1/3)  
 12.5 1/2    M5-12    M8    M10, 12    s 5-10 mm
- ⑦ **Tool Set 163-141/31, 31 pieces** (3/3)
- ⑧ **Pliers Set 163-96/3, 3 pieces** (1/3)
- ⑨ **Lockring Pliers Set 163-124/4, 4 pieces** (1/3)
- ⑩ **Soft Foam Insert with Compartments for Small Pieces 163-522 x 50**
- ⑪ **Wrench Set 163-30/25, 25 pieces** (3/3)  
 s 6-24 mm    s 6x7-21x22 mm
- ⑫ **Ratcheting Combination Wrench Set 163-97/6, 6 pieces** (1/3)  
 s 8, 10, 12, 13, 17, 19 mm
- ⑬ **Double Open End Wrench Set 163-95/8, 8 pieces** (1/3)  
 s 6x7-21x22 mm

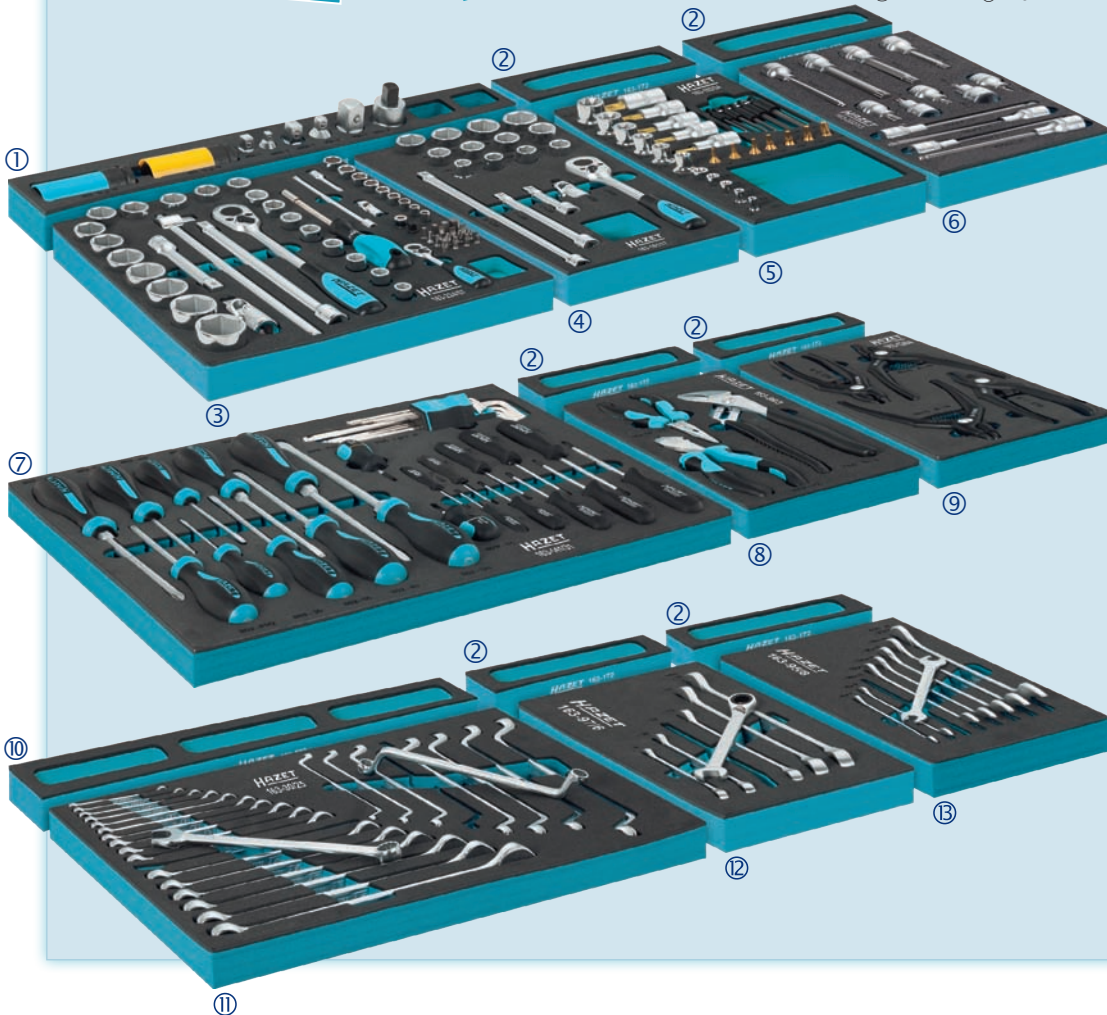

Screwdriver Bit Set  
2240/36, 36 pieces



Twist Drill Bits in Case  
2128-1, 25 pieces  
Ø 1-13 mm



Assistant® 179 T XXL-7/223

223 expert tools!



- ① **TORX® Tool Set 163-252/9, 9 pieces**  
10 3/8 ⚙ E8 E10 E12 E14 ⚙ T25 T30 T40 T45 T50
- ② **TORX® Tool Set 163-251/14, 14 pieces**  
6.3 1/4 ⚙ E4 E5 E6 E7 E8 E10 E11  
10 ⚙ T10 T15 T20 T25 T27 T30 T40
- ③ **Socket Set 163-131/8** (3/3 extension)  
12.5 1/2 s 17 mm 12.5 1/2 s 19 mm 10 3/8 ⇨ 6.3 1/4 20 3/4 ⇨ 12.5 1/2  
12.5 1/2 ⇨ 10 3/8 12.5 1/2 ⇨ 20 3/4 10 3/8 ⇨ 12.5 1/2 6.3 1/4 ⇨ 10 3/8
- ④ **Screwdriver Sockets 163-119/23, 23 pieces** (2/3)  
12.5 1/2 ⚙ s 5–19 mm ⚙ s 8–18 mm
- ⑤ **Socket Set 163-57/56, 56 pieces** (3/3)  
6.3 1/4 s 4–14 mm 12.5 1/2 s 10–34 mm
- ⑥ **Soft Foam Insert with Compartments for Small Pieces 163-522 x 50**
- ⑦ **Wrench Set 163-30/25, 25 pieces** (3/3)  
10 ⚙ s 6–24 mm 10 ⚙ s 6x7–21x22 mm
- ⑧ **Tool Set 163-31/27, 27 pieces** (3/3)  
10 ⚙ ⚙ ⚙

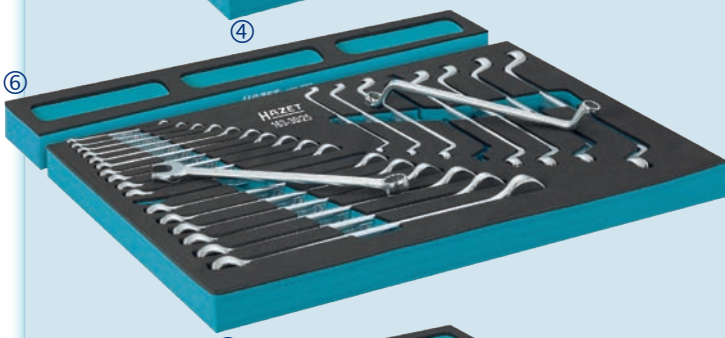
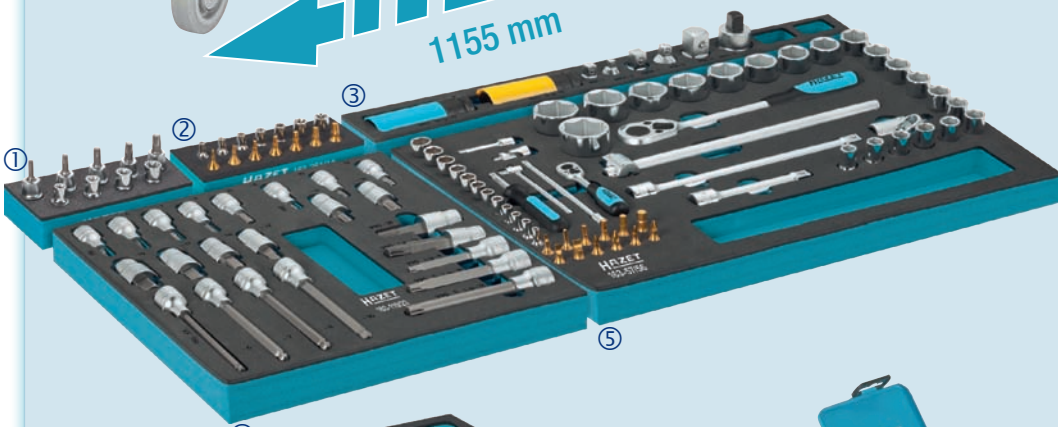
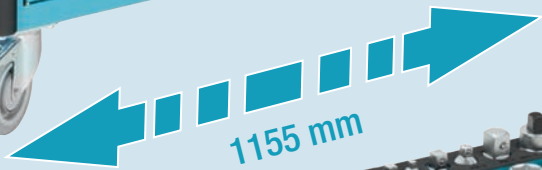

**Screwdriver Bit Set 2240/36, 36 pieces**  
10 ⚙ ⚙ ⚙ ⚙ ⚙ ⚙



**Twist Drill Bits in Case 2128-1, 25 pieces**  
 Ø 1–13 mm



**AUDI recommends  
HAZET Service Tool Trolley  
and Assortment**

**1** *Assistent*<sup>®</sup> 179-8-RAL7021

Made in Germany



**2** Standard Assortment 0-2500-163/214

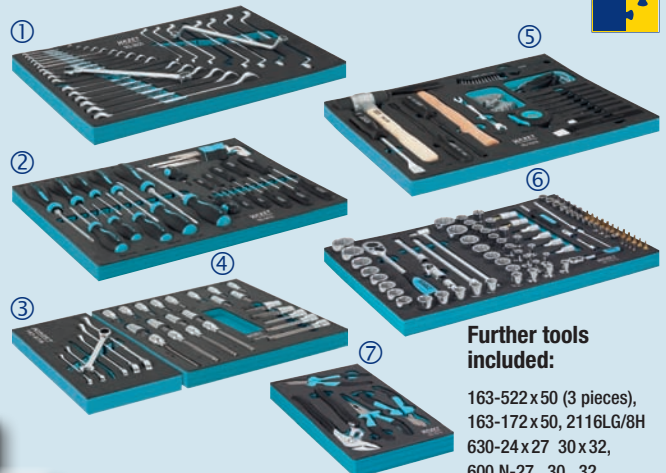

**Further tools included:**

163-522x50 (3 pieces),  
163-172x50, 2116LG/8H  
630-24x27 30x32,  
600 N-27 30 32  
650-20, 1841MA-22

- ① **Wrench Set 163-30/25, 25 pieces** (3/3)  
 s 6-24 mm s 6x7-21x22 mm
- ② **Screwdriver Set 163-141/31, 31 pieces** (3/3)
- ③ **Ratcheting Combination Wrench Set 163-97/6, 6 pieces** (1/3)  
 s 8, 10, 12, 13, 17, 19 mm
- ④ **Screwdriver Sockets 163-119/23, 23 pieces** (2/3)  
 12<sup>24</sup> 1/2 s 5-19 mm s 8-18 mm
- ⑤ **Universal Set 163-143/18, 18 pieces** (3/3)
- ⑥ **Socket Set 163-258/92, 92 pieces** (3/3)  
 6<sup>3</sup> 1/4 s 4-14 mm E4-E8  
 12<sup>24</sup> 1/2 s 10-32 mm 8 s 8-32 mm T30-T60 E10-E20
- ⑦ **Pliers Set 163-257/4, 4 pieces** (1/3)

**3** Expansion Tool Assortment 0-2500-163/86

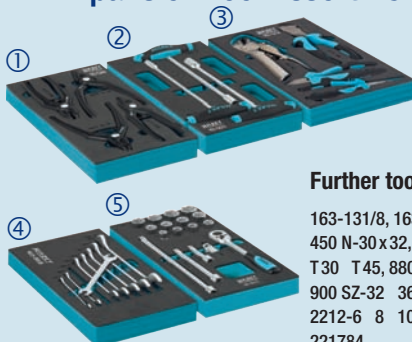

**Further tools included:**

163-131/8, 163-172x50 (2 pieces), 426-8,  
450 N-30x32, 803 Lg-T15 T20 T25  
T30 T45, 880 TZ/10 H, 880 G/10 H,  
900 SZ-32 36, 918-23, 1015/2, 2211-4 5,  
2212-6 8 10, 6420 b c, 8822-1 3 10,  
221784

- ① **Locking Pliers Set 163-124/4, 4 pieces** (1/3)
- ② **Hex Nut Driver Set 163-122/3, 3 pieces** (1/3)  
 s 8, 10, 13 mm
- ③ **Pliers Set 163-121/4, 4 pieces** (1/3)
- ④ **Double Open-End Wrench Set 163-95/8, 8 pieces** (1/3)  
 s 6x7-21x22 mm
- ⑤ **Socket Set 163-181/17, 17 pieces** (1/3)  
 10 3/8 s 10-22 mm

**Composition**

**1 + 2**  
179-8-RAL 7021/214

**1 + 2 + 3**  
179-8-RAL 7021/300



**HAZET – Official tool supplier of Mercedes-Benz Global TechMasters**

**MERCEDES-BENZ Tool Trolley *Assistant*<sup>®</sup>**

179-8-2700-163/296

**296 expert tools!**



*Assistant*  
2-component Safety-Insert-System



**Further tools included:**

163-130L (2x), 163-522x50 (6x),  
180-38, 426-6 7 8, 450N-24x27 30x32,  
600N-27 30 32, 612-10x1,  
630-24x27 30x32, 650-20,  
803Lg-T15 T20 T25 T30 824 828-T45,  
880G/10H, 880TZ/10H, 900SZ-32 34 36,  
918-23, 1015/2, 1952-35, 1976, 2130, 2147,  
2154-10, 2154N-5, 2160, 2165-2,  
2211-4 5, 2212-6 8 10,  
6420B, 6420C

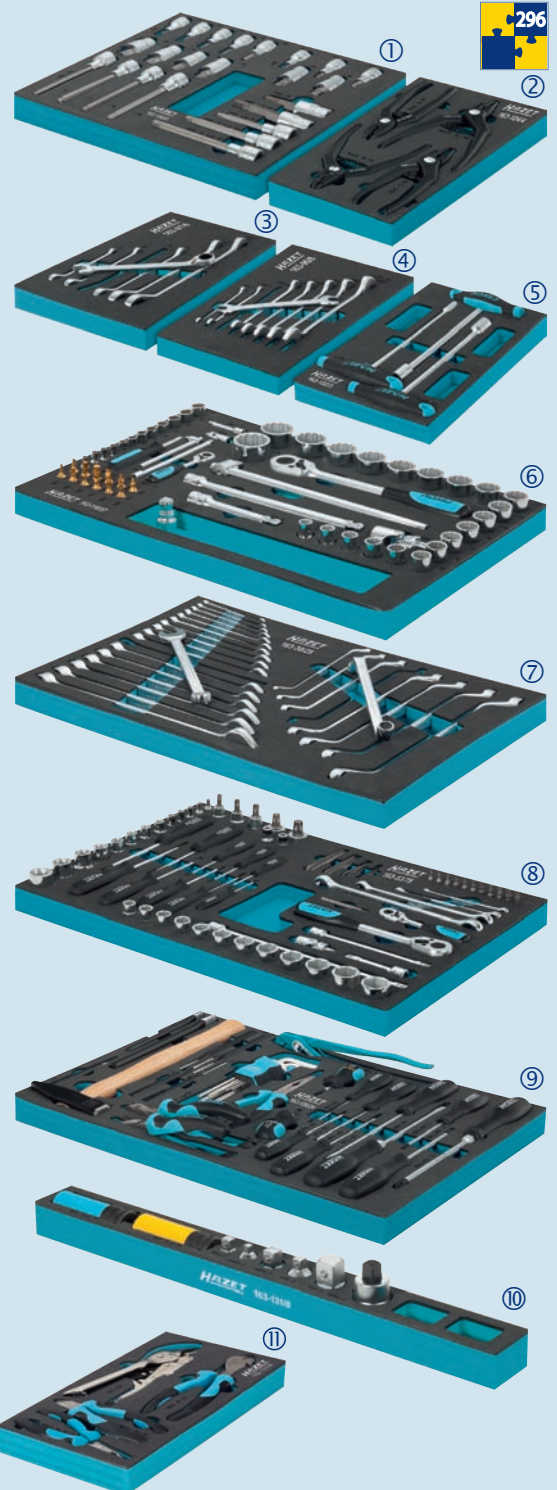

- ① **Socket Set 163-119/23** (2/3)  
12<sup>25</sup> 1/2 s 5-19 mm    s 8-18 mm
- ② **Lockring Pliers Set 163-124/4** (1/3)  
○ ●
- ③ **Ratcheting Combination Wrench Set 163-97/6** (1/3)  
↔ s 8, 10, 12, 13, 17, 19 mm
- ④ **Double Open End Wrench Set 163-95/8** (1/3)  
↔ s 6x7-21x22 mm
- ⑤ **Hex Nut Driver Set 163-122/3, 3 pieces** (1/3)  
● s 8, 10, 13 mm
- ⑥ **Socket Set 163-118/57** (3/3)  
6.3 1/4 s 4-14 mm    12<sup>25</sup> 1/2 s 10-34 mm
- ⑦ **Wrench Set 163-30/25** (3/3)  
↔ s 6-24 mm    ↔ s 6x7-21x22 mm
- ⑧ **TORX<sup>®</sup> Socket Set 163-53/75** (3/3)  
⊕ T6-T60    ⊕ E4-E24    ⊕ T7H-T40H    6.3 1/4 10 3/8 s 10-22 mm    12<sup>25</sup> 1/2
- ⑨ **Universal Set 163-120/24** (3/3)  
⊖ ⊕ ○
- ⑩ **Socket Set 163-131/8** (3/3 extension)  
12<sup>25</sup> 1/2 s 17 mm    12<sup>25</sup> 1/2 s 19 mm    10 3/8 ⇨ 6.3 1/4    20 3/4 ⇨ 12<sup>25</sup> 1/2  
 12<sup>25</sup> 1/2 ⇨ 10 3/8    12<sup>25</sup> 1/2 ⇨ 20 3/4    10 3/8 ⇨ 12<sup>25</sup> 1/2    6.3 1/4 ⇨ 10 3/8
- ⑪ **Pliers Set 163-121/4** (1/3)



### Tool Trolley *Assistant* 177

Made in Germany

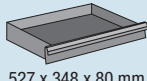

527 x 348 x 80 mm

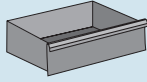

527 x 348 x 165 mm

HAZET No.				kg
177-6	4 x	2 x	6 x	60
177-7	6 x	1 x	7 x	62



3/3

### Tool Trolley *Assistant* 178

Made in Germany

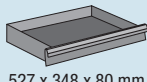

527 x 348 x 80 mm

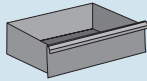

527 x 348 x 165 mm

HAZET No.				kg
178-6	3 x	3 x	6 x	80.5
178-7	5 x	2 x	7 x	82

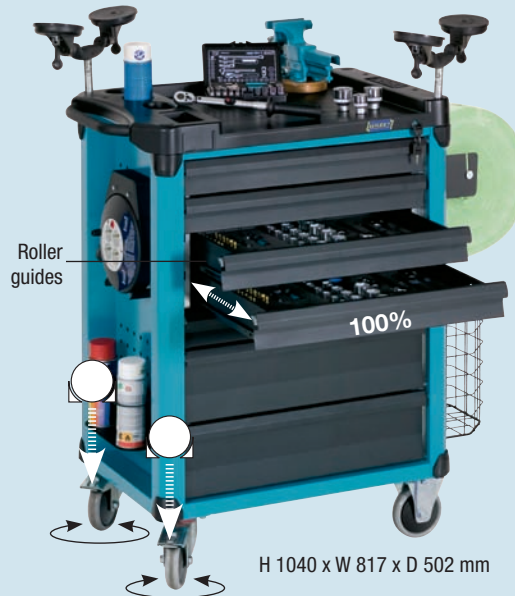

3/3

### Tool Trolley *Assistant* 179

Made in Germany

+13%

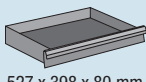
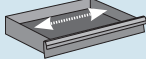

527 x 398 x 80 mm

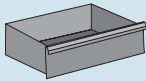

527 x 398 x 165 mm

HAZET No.				kg
179-6	3 x	3 x	6 x	88
179-7	5 x	2 x	7 x	90
179-8	7 x	1 x	8 x	92

Ball-bearing telescopic rails

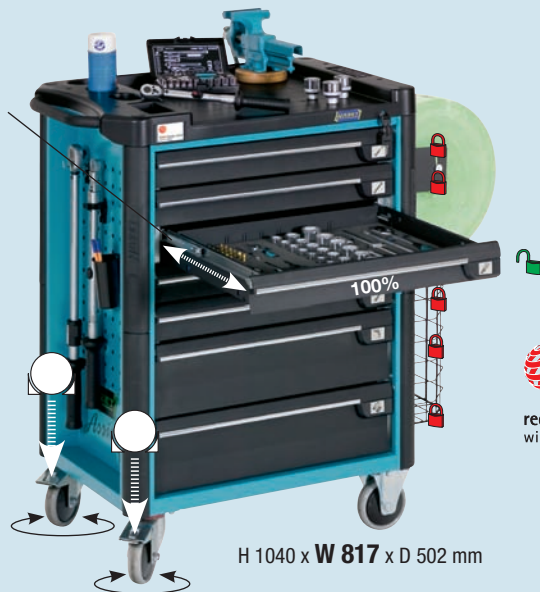

3/3

Awarded with the  
reddot design award  
winner 2008

### Tool Trolley *Assistant*<sup>®</sup> 179 XL

Made in Germany

+40%

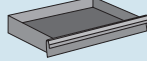
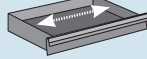

694 x 398 x 80 mm

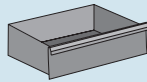

694 x 398 x 165 mm

Optional!

Wooden board  
179 XL-22

Self-closing and  
Soft-close

HAZET No.				kg
179 XL-6	3 x	3 x	6 x	95
179 XL-7	5 x	2 x	7 x	101
179 XL-8	7 x	1 x	8 x	106.5
179 XL-21	-	-	-	4.0
179 XL-22	-	-	-	3.0
179 XL-26	-	-	-	3.3

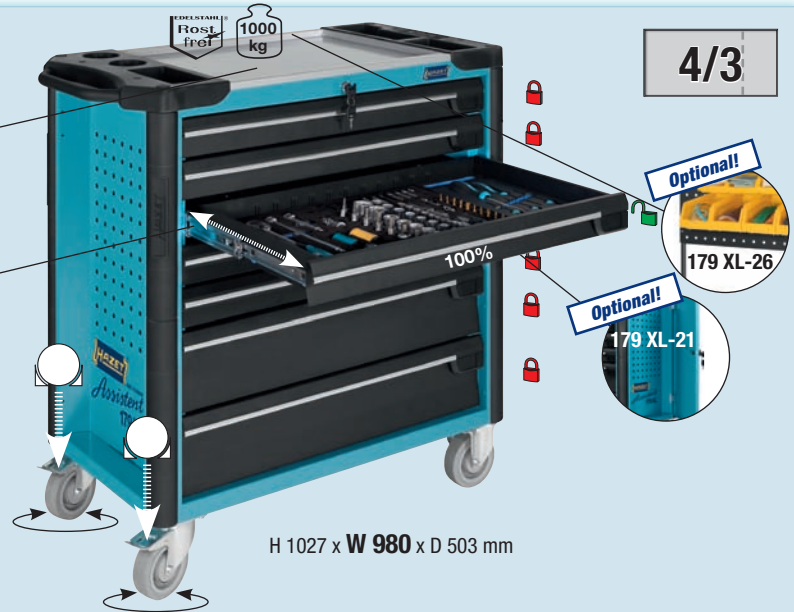

H 1027 x W 980 x D 503 mm

### Tool Trolley *Assistant*<sup>®</sup> 179 XXL

Made in Germany

+80%

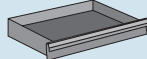
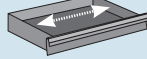

871 x 398 x 80 mm

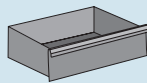

871 x 398 x 165 mm

Optional!

Wooden board  
179 XXL-22

Self-closing and  
Soft-close

HAZET No.				kg
179 XXL-6	3 x	3 x	6 x	118
179 XXL-7	5 x	2 x	7 x	122
179 XXL-8	7 x	1 x	8 x	127
179 XL-21	-	-	-	4.0
179 XXL-22	-	-	-	3.3
179 XXL-26	-	-	-	4.1

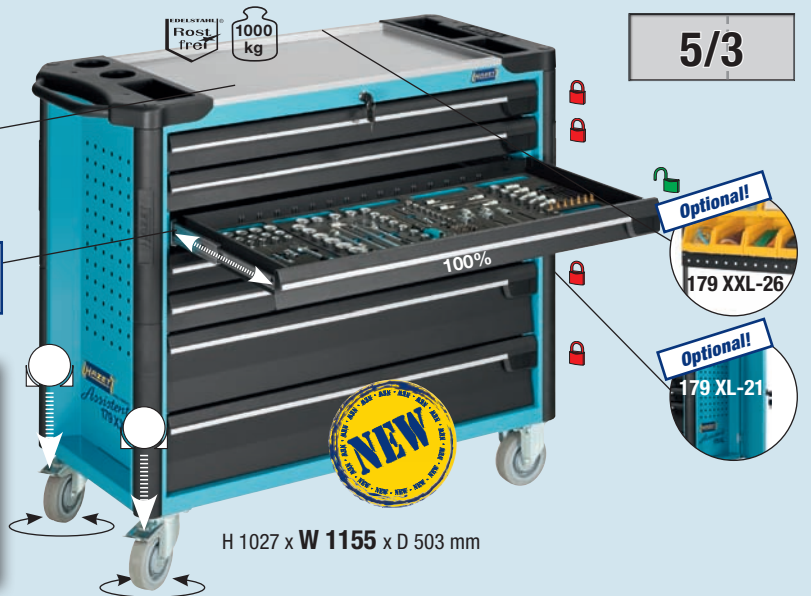

H 1027 x W 1155 x D 503 mm

### Tool Trolley *Assistant*<sup>®</sup> 179 TXXL

Made in Germany

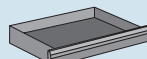

527 x 398 x 80 mm

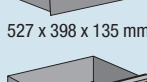

527 x 398 x 135 mm

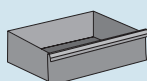
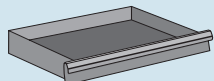

871 x 398 x 80 mm

527 x 398 x 165 mm

Optional!

Wooden board  
179 TXXL-22

Self-closing and  
Soft-close

HAZET No.					kg
179 TXXL-6	1	2	1	2	118
179 TXXL-7	1	4	1	1	121
179 XL-21	-	-	-	-	4.0
179 TXXL-22	-	-	-	-	3.3
179 TXXL-26	-	-	-	-	4.1



H 1027 x W 1155 x D 503 mm



### Mobile Work Bench 177 W

Made in Germany

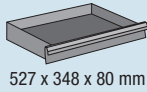
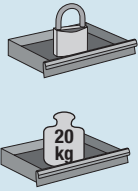

527 x 348 x 80 mm

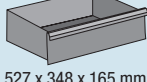

527 x 348 x 165 mm

HAZET No.				kg
177 W-6	4 x	2 x	6 x	85
177 W-7	6 x	1 x	7 x	87
177 W-21	-	-	-	2

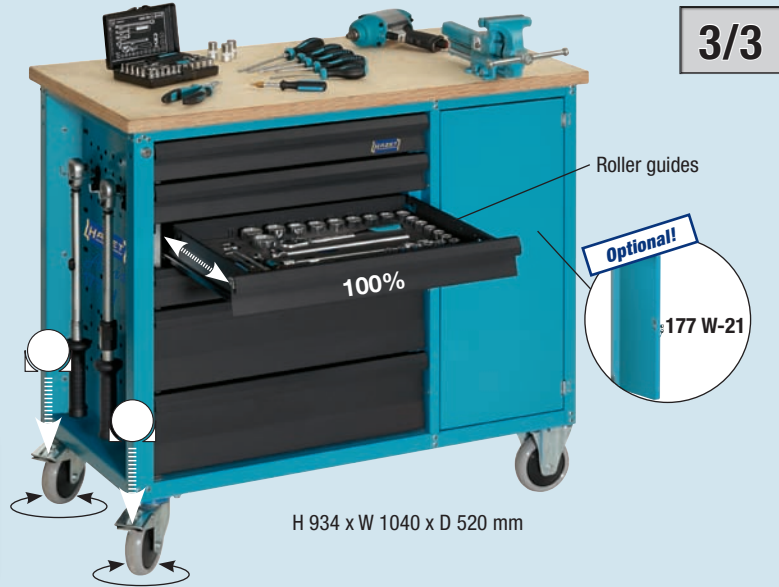

### Mobile Work Bench 179 W

Made in Germany

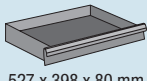

527 x 398 x 80 mm

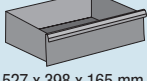

527 x 398 x 165 mm

HAZET No.				kg
179 W-5	2 x	3 x	5 x	110
179 W-7	6 x	1 x	7 x	112
179 W-21	-	-	-	6.5
179 W-22	-	-	-	3.0
179 W-23	-	-	-	1.7

Ball-bearing telescopic rails

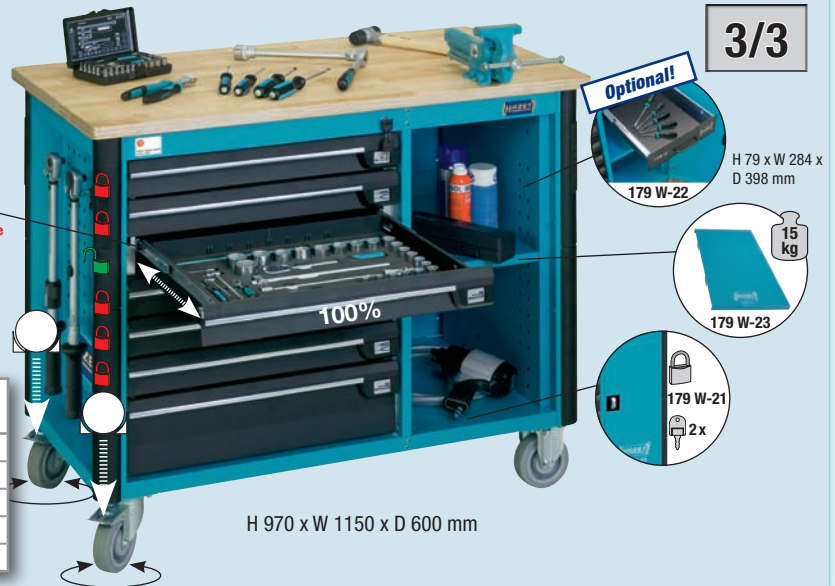

### Tool Trolley *Assistant* 179 BIG-1

Made in Germany

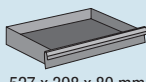

527 x 398 x 80 mm

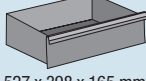

527 x 398 x 165 mm

HAZET No.				kg
179 BIG-1	11 x	2 x	13 x	180
179 BIG-21	Lateral door, lockable			8.2

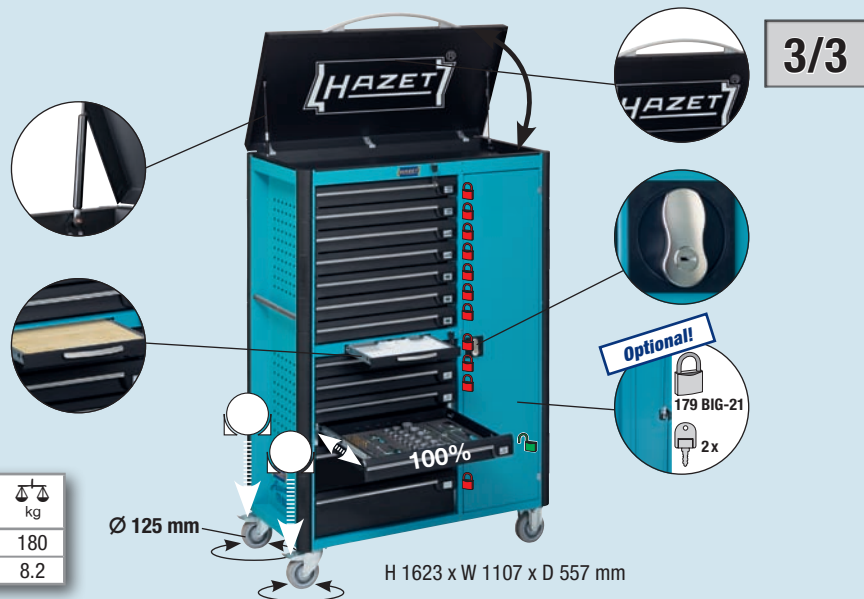

## Tool Trolley *Standard* 160 ST

Germany **Made in Germany**



H 950 (435) x W 590 x D 345 mm     $\frac{1}{2}$  16.5 kg

## Tool Trolley *Assistant* 166 N

Germany **Made in Germany**



H 975 (465) x W 680 x D 350 mm     $\frac{1}{2}$  24.5 kg

## Tool Trolley *Assistant* 166 C

Germany **Made in Germany**



H 1102 (647) x W 725 x D 398 mm     $\frac{1}{2}$  27.6 kg

162 C / 166 C, 168, 169 N, 174, 176, 177, 177 W, 178

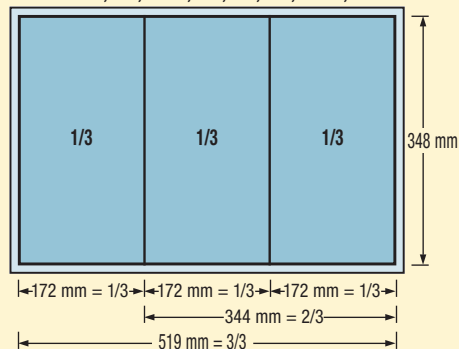

179, 179 W, 180

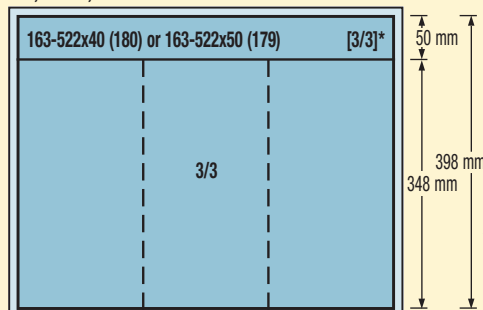

\* Optionally [1/3]: 163-172x40 (180) or 163-172x50 (179)



173, 179 XL

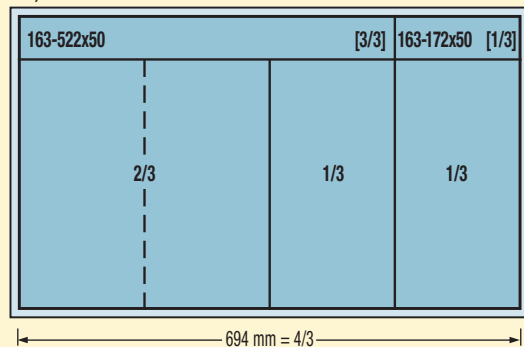

179 XXL, 179 T XXL

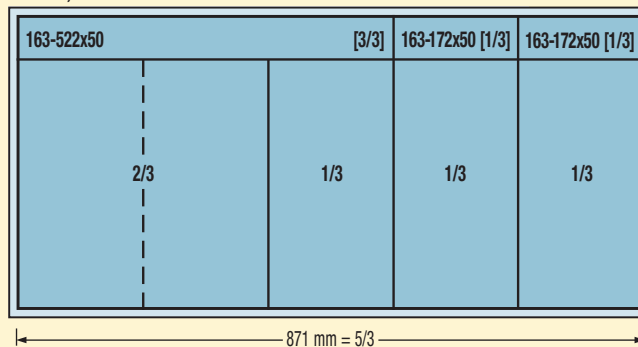

## Tool Set 163-60/22



(3/3)

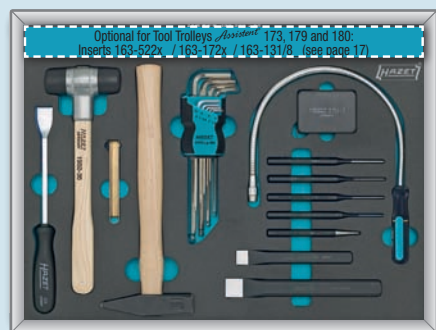

Germany **Made in Germany**

## Tool Set 163-58/27



s 6–24 mm

(3/3)

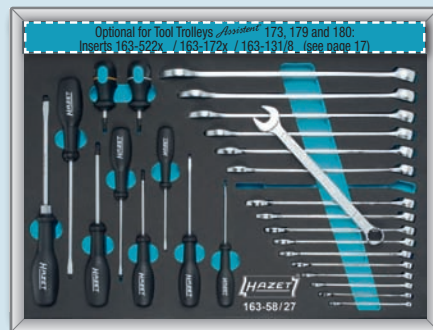

## Tool Set 163-31/27



(3/3)





### Socket Set

163-57/56



6.3 1/4 s 4-14 mm 12.9 1/2 s 10-34 mm

(3/3)



Made in Germany

### TORX® Socket Set

163-53/75



T6-T60 E4-E24 T7H-T40H

6.3 1/4 10 3/8 s 10-22 mm 12.9 1/2

(3/3)

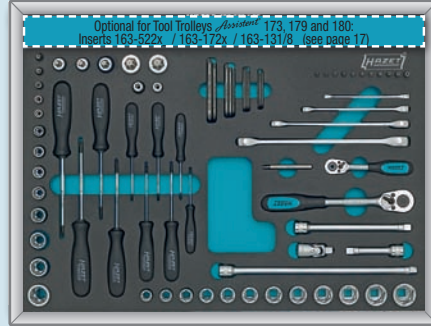

Made in Germany

### Socket Set

163-138/77



6.3 1/4 s 4-14 mm 12.9 1/2 s 10-32 mm

(3/3)



Only for 173, 179, 180  
Made in Germany

### Socket Set

163-139/90



T6-T60 E4-E24

6.3 1/4 10 3/8 s 7-22 mm

(3/3)



Only for 173, 179, 180  
Made in Germany

### Wrench Set

163-30/25



s 6-24 mm

s 6x7-21x22 mm

(3/3)

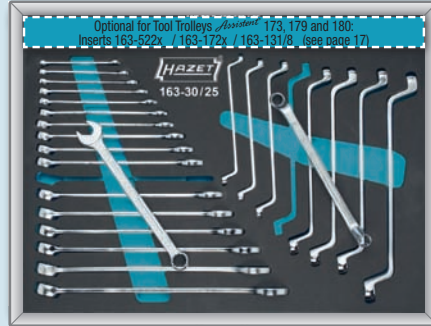

Made in Germany

### Wrench Set

163-140/33



s 6-24 mm s 6x7-21x22 mm

s 6x7-21x22 mm

(3/3)



Only for 173, 179, 180  
Made in Germany

### Screwdriver Set

163-141/31



Icons for screwdriver types

(3/3)



Only for 173, 179, 180

### Pliers Set

163-142/9



(3/3)

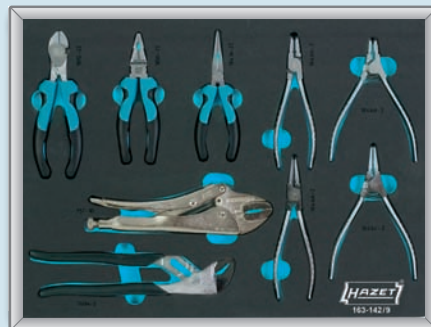

Only for 173, 179, 180  
Made in Germany

### Universal Set

163-143/18



(3/3)



Only for 173, 179, 180



### Soft Foam Insert Extensions

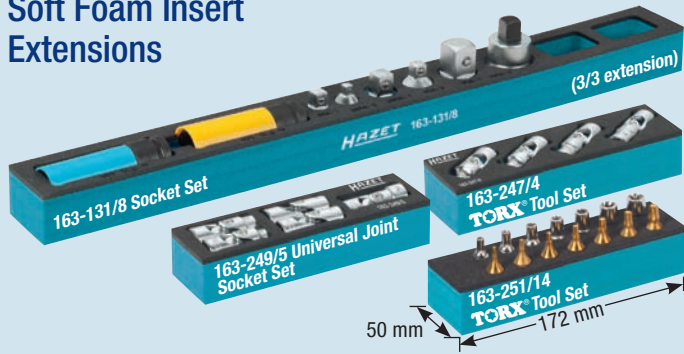

HAZET No.	Contents								
163-131/8	<table border="0"> <tr> <td> 1/2 s 17 mm</td> <td> 1/2 s 19 mm</td> <td> 3/8 s 10 mm</td> <td> 1/2 s 14 mm</td> </tr> <tr> <td> 1/2 s 10 mm</td> <td> 1/2 s 12 mm</td> <td> 3/8 s 10 mm</td> <td> 1/2 s 14 mm</td> </tr> </table>	1/2 s 17 mm	1/2 s 19 mm	3/8 s 10 mm	1/2 s 14 mm	1/2 s 10 mm	1/2 s 12 mm	3/8 s 10 mm	1/2 s 14 mm
1/2 s 17 mm	1/2 s 19 mm	3/8 s 10 mm	1/2 s 14 mm						
1/2 s 10 mm	1/2 s 12 mm	3/8 s 10 mm	1/2 s 14 mm						
163-247/4	E 8, E 10, E 12, E 14								
163-249/5	s 10, 12, 13, 14, 16 mm								
163-251/14	E 4 – E 11  T 10 – T 40								

### Soft Foam Inserts with Compartments for Small Pieces

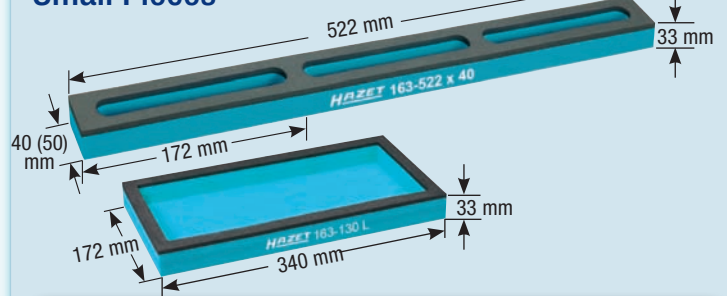

HAZET No.	sizes	Suitable for Assistant
163-130L	H 33 x W 340 x D 172 mm	173, 179, 180
163-172x40	H 33 x W 172 x D 40 mm	180
163-172x50	H 33 x W 172 x D 50 mm	173, 179, 179W
163-522x40	H 33 x W 522 x D 40 mm	180
163-522x50	H 33 x W 522 x D 50 mm	173, 179, 179W

### Tool Set 163-224/57



1/4 1/4 1/2 1/2 1/4 1/4

(2/3)



### Socket Set 163-102/27



1/2 s 10–34 mm

(2/3)



Made in Germany

### Socket Set 163-119/23



1/2 s 5–19 mm s 8–18 mm

(2/3)



Made in Germany

### Combination Wrench Set 163-98/17



s 6–24 mm (2/3)



Made in Germany

### Combination Wrench Set 163-99/18



s 6–27 mm (2/3)



Made in Germany

### Ratcheting Combination Wrench Set 163-186/16



s 8–19 mm (2/3)



Made in Germany

### Double Box-End Wrench Set 163-101/9



s 6x7–21x23 mm (2/3)



Made in Germany

### Screwdriver Set 163-100/13



(2/3)

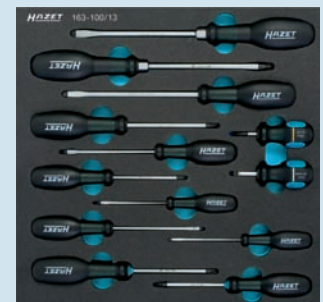



### VDE Tool Set 163-230/18



10 3/8 s 6-22 mm

(1/3)



### Socket Set 163-181/17



10 3/8 s 10-22 mm

(1/3)



Made in Germany

### Socket Set 163-191/18



125 1/2 s 10-27 mm

(1/3)



Made in Germany

### TORX® Socket Set



163-192/24 6.3 1/4 125 1/2

T8-T55 E5-E20 (1/3)



Made in Germany

### Socket and Bit Set



163-193/40

6.3 1/4 s 5.5-14 mm

(1/3)



Made in Germany

### Socket Set 163-233/36



10 3/8 s 8-22 mm 6.3 1/4 s 5-8 mm

E6-E14 T10-T40 (1/3)

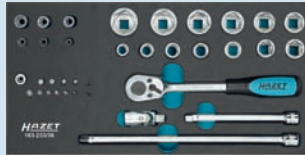

Made in Germany

### Socket Set 163-237/47



6.3 1/4 s 5-13 mm 125 1/2 s 10-27 mm

6.3 1/4 8 9/16 (1/3)



### Hex Nut Driver Set 163-122/3



s 8, 10, 13 mm

(1/3)

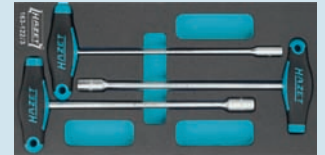

Made in Germany

### Ratcheting Com- bination Wrench Set 163-97/6



s 8, 10, 12, 13, 17, 19 mm

(1/3)



### Double Open- End Wrench Set



163-95/8

s 6x7-21 x22 mm (1/3)



Made in Germany

### Screwdriver Set 163-265/6



PH 1, PH 2 3-6.5 mm

(1/3)



### TORX® Screwdriver Set 163-266/6



T10-T30

(1/3)



### HEXAnamic- Screwdriver Set 163-184/6



PH 1, PH 2 4-8 mm

(1/3)

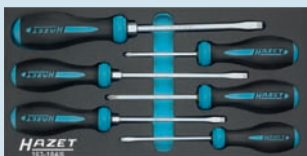

### VDE Screwdriver Set



163-229/7

PH 1-PH 3 2.5-4 mm (1/3)



### HEXAnamic- TORX® Screw- driver Set 163-185/5



T10H-T30H

(1/3)

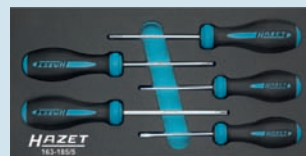

### T-Handle Inside Hexagon Screw- driver Set with double blade



163-189/6 s 2-6 mm (1/3)

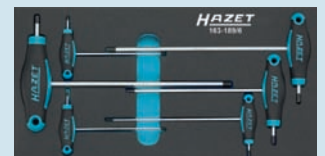

**T-Handle TORX® Screwdriver Set 163-182/9**  
 T6-T30 (1/3)



**T-Handle TORX® Screwdriver Set 163-190/6** with double blade  
 T15-T40 (1/3)



**Screwdriver Socket Set 163-220/13**  
 s 5-19 s 6-10 (1/3)



Made in Germany

**XZN Screwdriver Socket Set 163-221/10**  
 M 8-M 18 (1/3)



Made in Germany

**XZN Screwdriver Socket Set 163-222/13**  
 M 5-M 12 s 6-10 mm (1/3)



Made in Germany

**Pliers Set 163-269/3**



**Lockring Pliers Set 163-124/4**



**VDE Pliers Set 163-226/4**



Made in Germany

**VDE Pliers Set 163-227/3**



Made in Germany

**TORX® Tool Set 163-245/12**  
 E 10-E 20 T 30-T 60 (1/9)



Made in Germany



**Screwdriver Socket Set 163-215/5**  
 s 5, 6, 7, 8, 10 mm (1/9)



Made in Germany



**TORX® Screwdriver Socket Set 163-216/5**  
 T 30H-T 55H (1/9)



Made in Germany

**TORX® Screw Driving Tool Set 163-218/10**  
 T8-T15 T10-T20 T40-T60 (1/9)



Made in Germany

**RIBE-CV Screwdriver Socket Set 163-250/7**  
 M6-M14 (1/9)



Made in Germany

**XZN Screwdriver Socket Set 163-243/7**  
 M6-M18 (1/9)



Made in Germany

**Adapter Set 163-217/6**  
 T8-T15 T10-T20 T40-T60 (1/9)



Made in Germany



### Socket Set 856-1

6.3 1/4



- New, ergonomic design
- Ready to hand when needed
- H 52 x W 180 x D 98mm
- 780 g
- **Made in Germany**

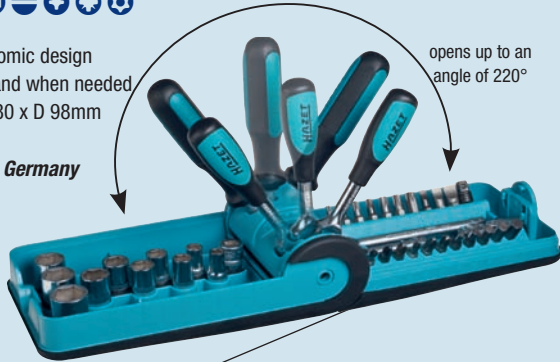

opens up to an angle of 220°

With anti-slip coating



10 x		s 5.5 6 7 8 9 10 11 12 13 14 mm
1 x		
1 x		
2 x		55 105.5 mm
5 x		s 3 4 5 6 7 mm
3 x		6 10 11 mm
3 x		PH 1 PH 2 PH 3
3 x		PZ 1 PZ 2 PZ 3
7 x		T 10 H T 15 H T 20 H T 25 H T 27 H T 30 H T 40 H
1 x		
1 x		
1 x		

### Socket Set 953 SPC

6.3 1/4 12.5 1/2

**TOPSELLER!**



9 x		s 5 6 7 8 9 10 11 12 13 mm
1 x		
1 x		
1 x		101.5 mm
5 x		s 2 3 4 5 6 mm
3 x		4 6 8 mm
2 x		PH 1 PH 2
2 x		PZ 1 PZ 2
5 x		T 10 T 15 T 20 T 25 T 30
1 x		
14 x		s 10 11 12 13 14 15 16 17 18 19 21 22 24 27 mm
1 x		
2 x		123 248 mm

### Fine-Tooth Reversible Ratchet 863-1 6.3 1/4 / 916-1 12.5 1/2

**Made in Germany**



HAZET No.	Description	l	g
863-1	Fine-Tooth Reversible Ratchet 6.3 1/4	119 mm	145 g
916-1	Fine-Tooth Reversible Ratchet 12.5 1/2	245 mm	560 g

### Combination Wrench Set 600 SPC/10

**Made in Germany**



10 x		600 N- 8 10 12 13 14 15 16 17 18 19 mm
------	--	---

### Screwdriver Sets in a Shopping Cart



HAZET No.	Description
810 SPC/5-SO	25 Screwdriver Sets in a Shopping Cart
810 U-1/5-SO	20 Screwdriver Sets in a shopping cart <b>Available in April!</b>
810 SPC/6-SO	25 Screwdriver Sets in a Shopping Cart
810 T SPC/6-SO	20 Screwdriver Sets in a Shopping Cart
810/6 VDE-SO	20 Screwdriver Sets in a Shopping Cart
810 SPC/6S-SO	20 Screwdriver Sets in a shopping cart <b>Available in April!</b>
1859 SPC/3-SO	20 Pliers Sets in a Shopping Cart

### Screwdriver Set 810 SPC/5



5 x 0.4 x 2.0 0.5 x 3.0 0.8 x 4.0  
1.0 x 5.5 1.2 x 6.5 mm

### HAZET Screwdriver Set 810 SPC/6



4 x 0.5 x 3.0 0.8 x 4.0 1.0 x 5.5 1.2 x 6.5 mm  
2 x PH 1 PH 2

### HAZET TORX® Screwdriver Set 810 T SPC/6



- Ergonomically shaped 3-component handle allows high power transmission

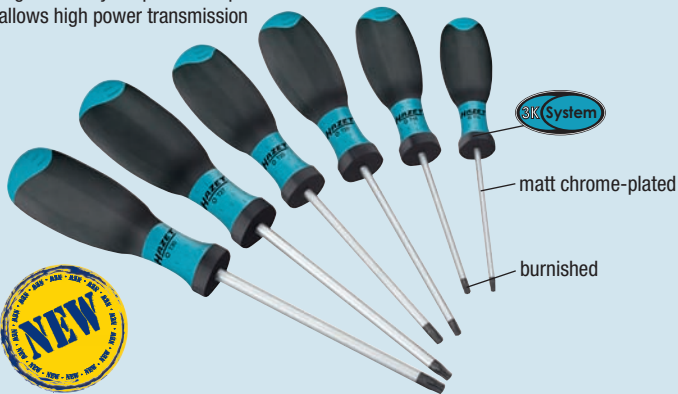

6 x T 10 T 15 T 20 T 25 T 27 T 30

### Screwdriver Set with Impact Cap 810 U-1/5



Available in April!

3 x 0.8 x 4.5 1.0 x 5.5 12.5 x 7 mm  
2 x PH 1 PH 2

### Screwdriver Set 810 SPC/6S



- Common sizes, especially for professional carpenters



Available in April!

2 x 0.8 x 4.0 1.0 x 5.5 mm  
2 x PZ 1 PZ 2  
2 x T 20 T 25

### VDE Screwdriver Set for Electricians 810/6 VDE



2 x PH 1 PH 2  
3 x 2.5 x 0.4 3.5 x 0.6 4 x 0.8 mm  
1 x 220 - 250 V (according to standard VDE 0680)



### HEXAnamic- Screwdriver Set 802/5



Awarded  
with the

2009

3 x 0.8 x 4.0 1.0 x 5.5 1.2 x 6.5 mm  
2 x PH 1 PH 2

### Offset Screwdriver Set 2105 LG/9HC

- Coloured marking for quick identification of the required pattern
- Extra long pattern

Made in Germany

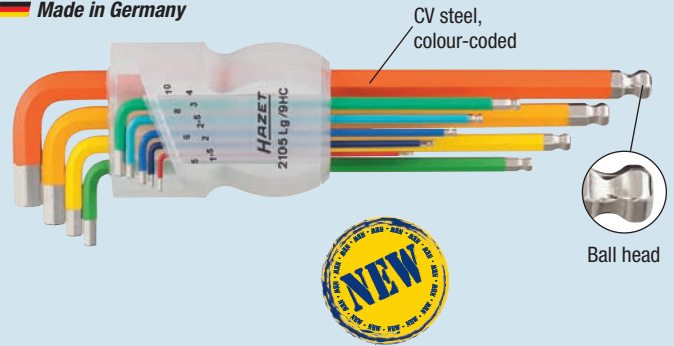

CV steel,  
colour-coded



Ball head

9 x s 1.5 2 2.5 3 4 5 6 8 10 mm

### Screwdriver Socket Set with TIN-coated blades 986/9

Made in Germany



1/9

9 x s 5 6 7 8 10 12 14 17 19 mm

### TORX® Screwdriver Socket Set with TIN-coated blades 992/9

Made in Germany



1/9

9 x T 20 T 25 T 27 T 30 T 40  
T 45 T 50 T 55 T 60

## TIN coating

### Why choose TIN (Titanium-Nitride) coating?

- ✓ A special coating process for extremely hard TIN-coating guarantees high adhesive strength and wear resistance of the coating
- ✓ Particularly suitable for continuous load, e.g. for industrial applications in industry and trade
- ✓ Higher wear protection guarantees a longer lifetime
- ✓ Perfect fitting accuracy through optimum coating thickness
- ✓ Higher torque
- ✓ Optimised corrosion protection



TIN

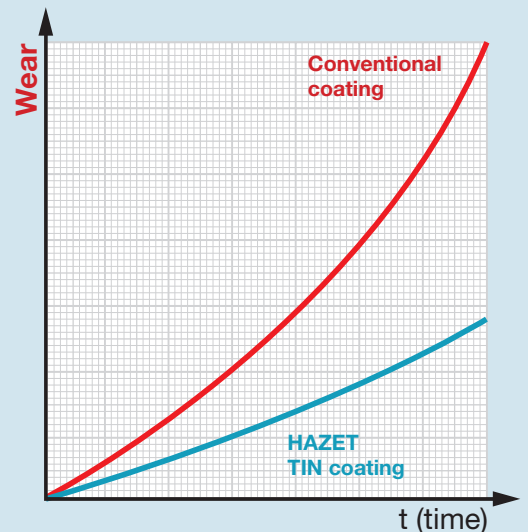

### Bit Holder 810 SPC-6.3

6.3 1/4"

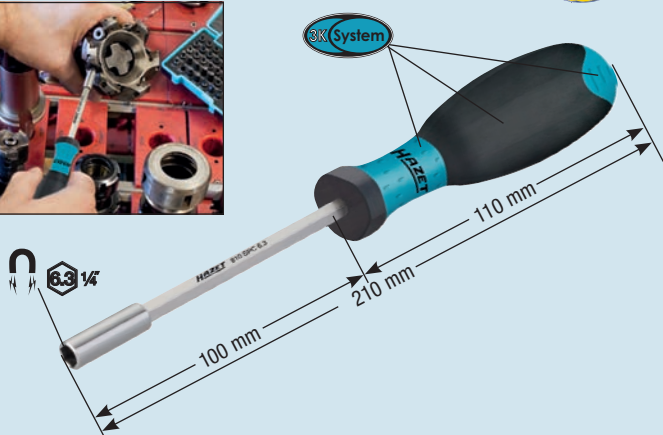

### Screwdriver Bit Set 2240/36

36

Made in Germany



1 x		Ø D 6.3 = 1/4" ● C 6.3
3 x		0.6 x 4.5 0.8 x 5.5 1.0 x 6.0 mm
7 x		PH 1(3x) PH 2(3x) PH 3(1x)
7 x		PZ 1(3x) PZ 2(3x) PZ 3(1x)
4 x		s 3 4 5 6 mm
12 x		T 10 (1x) T 15 (2x) T 20 (2x) T 25 (2x) T 27 (1x) T 30 (2x) T 40 (2x)
2 x		T 20 H T 30 H

### Screwdriver Bit Set 2263N/7

7

• Bit Holder included  
Made in Germany



3 x		3 x 0.5 4 x 0.5 5.5 x 0.8 mm
3 x		PH 1 PH 2 PH 3

### Screwdriver Bit Set 2263N-1/7

7

• Bit Holder included  
Made in Germany



6 x		s 2 2.5 3 4 5 6 mm
-----	--	--------------------

### Screwdriver Bit Set 2263NT/7 TORX®

7

• Bit Holder included  
Made in Germany



6 x		T 10 T 15 T 20 T 25 T 30 T 40
-----	--	-------------------------------

### Sales Display 2263N-VH

10

• 10 Bit Sets included  
Made in Germany



5 x	2263N/7	
3 x	2263NT/7	
2 x	2263N-1/7	



### Pliers Set 1859 SPC/3

Made in Germany



HAZET No.	Description
1859 SPC/3	Pliers Set
1859 SPC/3-SO	20 Pliers Sets 1859SPC/3 in a Shopping Cart

### Universal Thread Repair Tool 842 AG-1

- Range of thread diameters:  
4 – 13 mm ( $\frac{5}{32}$ " –  $\frac{1}{2}$ " )



### Drift Pin Set 751/6-2C

- Coloured marking for quick identification of the required pattern

Made in Germany



Exclusively polished high-quality execution, multi-coloured



6 x		3 4 5 6 8 10 mm
-----	--	-----------------

### Drift Pin Set 751 HS/5

- With hand guard:
  - Less risk of injury
  - Depressant effect
  - Safe gripping
- DIN 6450, form C

Made in Germany



5 x		3 4 5 6 8 mm
-----	--	--------------

### Tool Set for Hybrid and Electric Vehicles, in Trolley Case 150/43

- Joint development with one of the leading car manufacturer

#### Trolley Case:

- With 4-position telescopic slide-out from 950 – 1,150 mm
- Capacity: up to 40 kg
- Dimensions (not extended): H 310 x W 460 x D 190 mm

6.2 kg (empty)



HAZET No.	Description
150/43	Tool Set
196 VDE-8/2	Insulating mat



5 x each	End caps	Ø 10 20 mm
2 x	Warning signs "Hybrid" and "Hybrid-Switch"	
1 x	Barrier Tape	W 50 mm x L 500 m
4 x	VDE	2.5 3 3.5 4 mm
3 x	VDE	PH 1 PH 2 PH 3
3 x	VDE	T 20 T 25 T 30
15 x	VDE	6 7 8 9 10 11 12 13 14 16 17 18 19 20 22 mm
3 x	VDE	M 8 M 10 M 12
2 x	VDE	74 126 mm
1 x	VDE	
1 x	VDE	250 mm
1 x	VDE	180 mm
1 x	High-Leverage Diagonal Cutter VDE	160 mm
1 x	VDE	160 mm
1 x	VDE	200 mm
1 x	VDE	200 mm
1 x	Cable Stripping Knife VDE	

Individual articles see Illustrated List 2013, from page 140 on



## Quick-Clamping Puller Set 1786 FS/6-1

6

- To be used as internal and external puller by inverting the hooks
- Slender forged hooks especially suitable for gear box repair (as standard hooks cannot be used in areas with restricted access)



With clamping device

1 x 1786 S-03	Spindle G ½" x 210 mm
1 x 1786-22	2-arm Crossbar
1 x 1786-33	3-arm Crossbar
3 x -	Quick-Clamping Puller Hook (150 mm)

## Universal Ball Joint Puller 1779-1 / 1779-3

- Large clamping range 18–23 mm (1779-1)
- Universal application e.g. for light commercial vehicles (1779-3)

Made in Germany

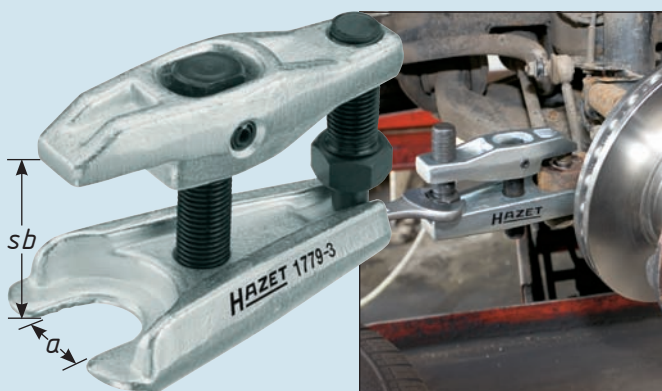

HAZET No.	sb max. mm	a mm	kg
1779-1	65	23	0.7
1779-3	85	32	2.5

## Universal Ball Joint Puller 1790-7

- Clamping range (sb) in 2 stages  
stage 1: up to 30 mm  
stage 2: up to 50 mm
- For: **FORD, BMW, VOLVO, TOYOTA, OPEL, VW-AUDI, RENAULT**

Made in Germany

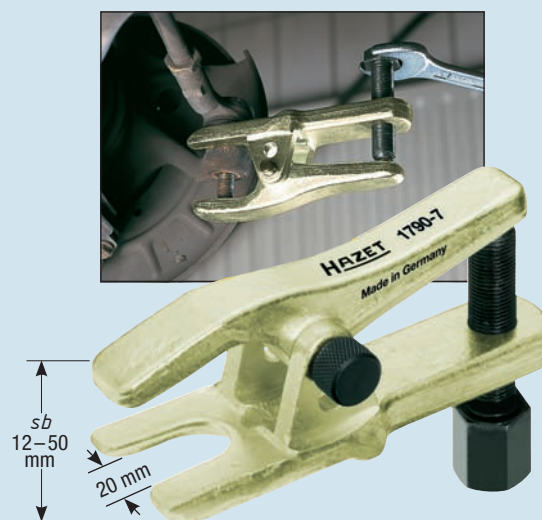



## Torque Wrenches SYSTEM 5000 CT 2.5 – 320 Nm 5108-2CT – 5123-2CT

6.3 1/4 10 3/8 125 1/2

- Release accuracy tolerance (in direction of actuation)  $\pm 4\%$  of scale value according to DIN EN ISO 6789:2003 (D)
- Square drive according to DIN 3120 A, ISO 1174-1A
- Safe torque release:
  - Palpable (close gap release)
  - Audible ("click" sound)

Made in Germany

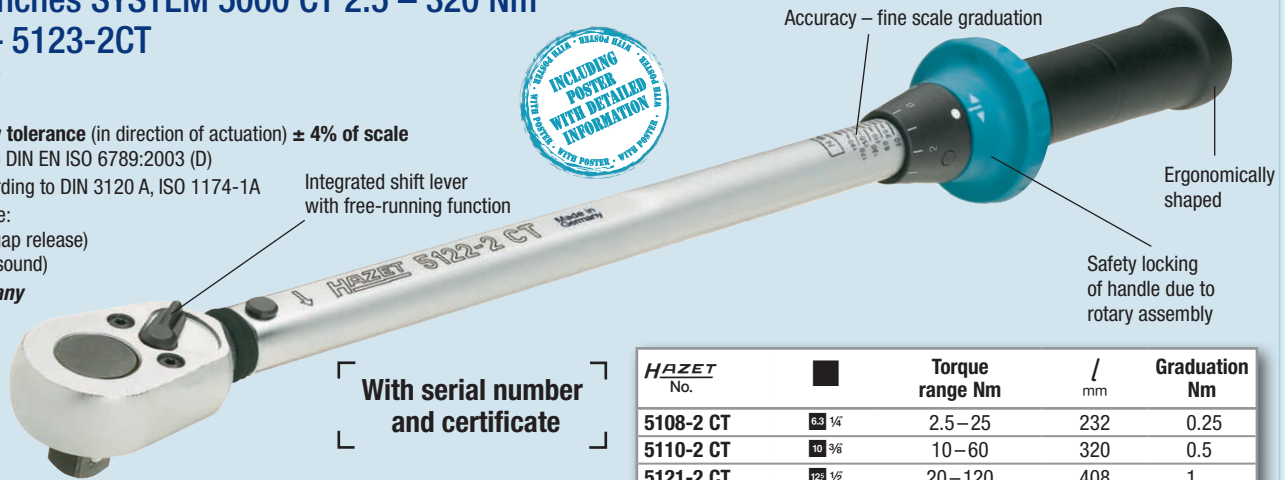

HAZET No.		Torque range Nm	l mm	Graduation Nm
5108-2 CT	6.3 1/4	2.5–25	232	0.25
5110-2 CT	10 3/8	10–60	320	0.5
5121-2 CT	125 1/2	20–120	408	1
5122-2 CT	125 1/2	40–200	513	1
5123-2 CT	125 1/2	60–320	632	2

## Extra short style 125 1/2 10 – 60 Nm 5120-2CT

Made in Germany

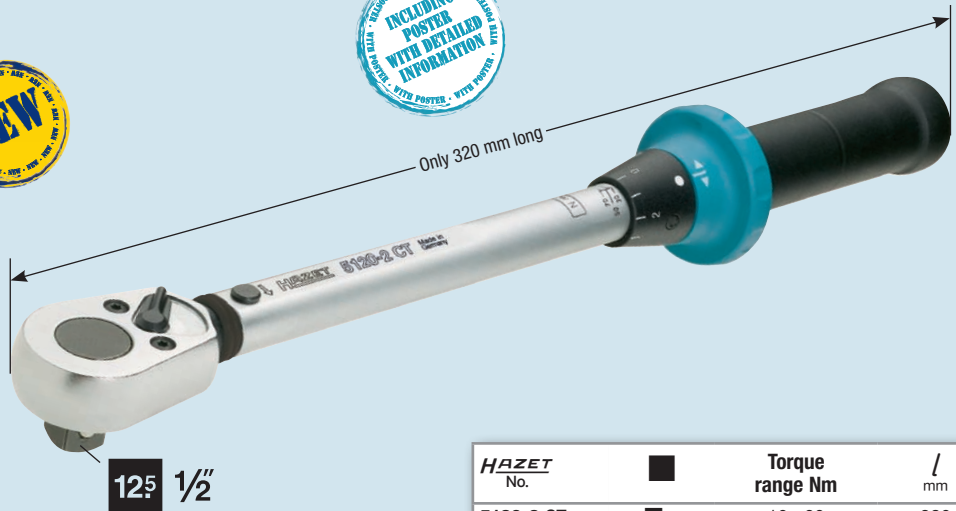

HAZET No.		Torque range Nm	l mm	Graduation Nm
5120-2 CT	125 1/2	10–60	320	0.5

## Electronic Torque Wrench with Built-in Angle Gauge – SYSTEM 7000 eTAC 20 – 200 Nm 7292-1 eTAC / 7292-2 eTAC

125 1/2

Made in Germany

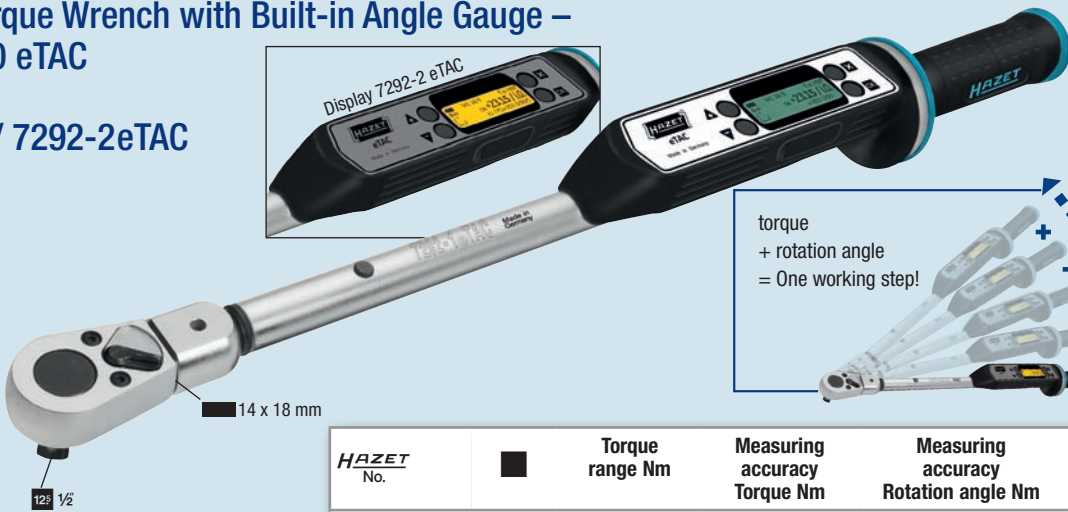

**HAZET-CHANNEL**  
Product presentation  
**7292-2 eTAC**

For detailed information see the HAZET Illustrated List from page 154 on

HAZET No.		Torque range Nm	Measuring accuracy Torque Nm	Measuring accuracy Rotation angle Nm	l mm	
7292-1 eTAC	125 1/2	20–200	$\pm 2\%$ / $\pm 1$ Digit	$\pm 2\%$ / $\pm 1^\circ$	518	0.98
7292-2 eTAC	125 1/2	20–200	$\pm 1\%$ / $\pm 1$ Digit	$\pm 1\%$ / $\pm 1^\circ$	518	0.98

**Torque Multiplier**  
**6800 ALU-700 – 6800 ALU-Lg 1400**

*Improved, light style made of aluminium.  
 Up to 30% less weight than  
 comparable steel version!*

- For tight screwed connections
- Low maintenance / High accuracy ± 5%
- For building and agricultural machines, commercial vehicles, plant and engine construction and ship building
- Avoids the application of lever arms, impact tools, etc., prevents screwed connections from damage

**6800 ALU-Lg 1400: Extra long pattern**  
 e.g. for deeply located wheel bolts / nuts on commercial vehicles  
**Made in Germany**



HAZET No.	■	□	Nm	Transmission ratio
6800 ALU-700	20 3/4	128 1/2	700	1:3.5
6800 ALU-1400	25 1	20 3/4	1400	1:3.5
6800 ALU-2800	25 1	20 3/4	2800	1:11
6800 ALU-Lg 1400	25 1	20 3/4	1400	1:3.5

**Torque Screwdriver** 3/4  
**6001-1.5/3 – 6001-5.4/3**



- For torque values from 0.6 up to 5.4 Nm
- Unlimited loosening torque without torque function
- Bit holding adapter with magnet for all current bits with 3/4 drive or with HAZET adapter 2304 for the connection to 3/4 sockets HAZET No. 850
- Release accuracy (tolerance) according to EN ISO 6789

**According to VW Service Information:**  
**6001-3.0/3:** e.g. for the fastening screws at the air-filter housing on 1.4 l engine with turbocharger on VW Eos, Golf, Golf Plus and Passat  
**Made in Germany**



HAZET No.		max. Nm	min. Nm	Tolerance %
6001-1.5/3	3/4	1.5	0.6	10
6001-3.0/3	3/4	3.0	1.5	6
6001-5.4/3	3/4	5.4	3.0	6

**Insert Reversible Ratchet**  
**6602-1 / 6604-1**

**NEW**

- Drop-forged
- Chrome-plated
- Deep-set reversing switch prevents unintentional change-over
- Square according to DIN 3120, ISO 1174-1
- Especially suitable for HAZET Torque Wrenches 6291-1 CT – 6293-1 CT

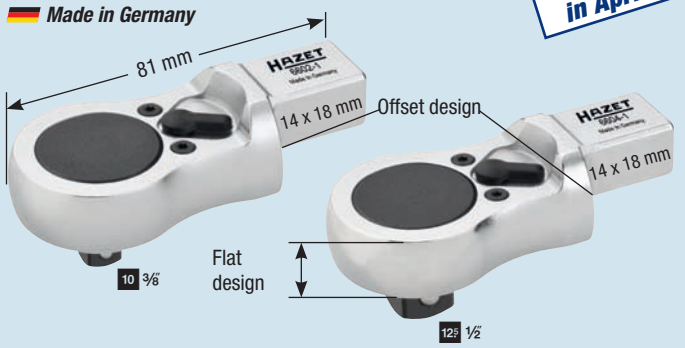

HAZET No.	Max. Torque Nm	Effective length mm	■	Teeth
6602-1	200	36	10 3/8	40
6604-1	320	36	128 1/2	40

**Ratcheting Insert Box Wrench**  
**6606D-16 – 6606D-21**

**NEW**

- Drop-forged
- Chrome-plated
- Deep-set reversing switch prevents unintentional change-over
- Square according to DIN 3120, ISO 1174-1
- Especially suitable for HAZET Torque Wrenches 6291-1 CT – 6293-1 CT



HAZET No.	Max. Torque Nm	Effective length mm	S mm	Teeth
6606D-16	320	36	16	40
6606D-17	320	36	17	40
6606D-18	320	36	18	40
6606D-19	320	36	19	40
6606D-21	320	36	21	40

Conventional application

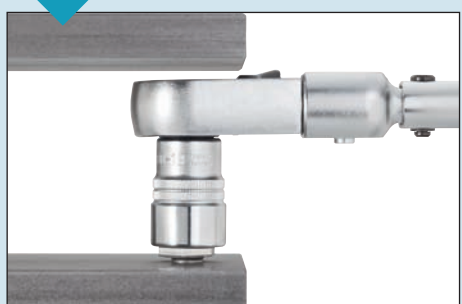

Insert Reversible Ratchet



Ratcheting Insert Box Wrench

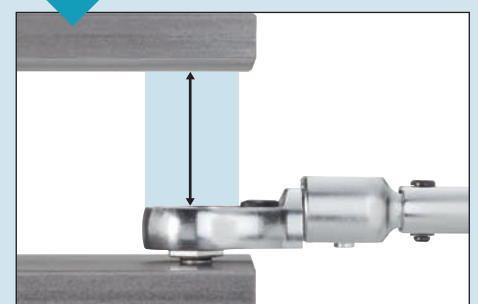



### Impact Wrench 9011 MG

10 3/8"



HAZET No.	■	max. Nm	Air consumption l/min	Working pressure bar	dB(A)	kg
9011 MG	10 3/8"	311	71	6.3	Lp A 97	1.3

### Impact Wrench 9012 SPC

125 1/2"



HAZET No.	■	max. Nm	Air consumption l/min	Working pressure bar	dB(A)	kg
9012 SPC	125 1/2"	750	127.4	6.3	Lp A 92.1	2.6

NEW GENERATION NEW DESIGN NEW GENERATION NEW DESIGN NEW GENERATION NEW DESIGN

### Impact Wrench 9012-1 SPC

125 1/2"



HAZET No.	■	max. Nm	Air consumption l/min	Working pressure bar	dB(A)	kg
9012-1SPC	125 1/2"	685	127	6.3	Lp A 94.4	2.5

### Impact Wrench 9012 MG

125 1/2"



HAZET No.	■	max. Nm	Air consumption l/min	Working pressure bar	dB(A)	kg
9012 MG	125 1/2"	750	133	6.3	Lp A 94.8	2.5

### Impact Wrench 9012 EL

125 1/2"



HAZET No.	■	max. Nm	Air consumption l/min	Working pressure bar	dB(A)	kg
9012 EL	125 1/2"	1054	144	6.3	Lp A 96	2.0

### Impact Wrench 9012 UL

125 1/2"



HAZET No.	■	max. Nm	Air consumption l/min	Working pressure bar	dB(A)	kg
9012 UL	125 1/2"	461	133	6.3	Lp A 90	1.2

### Impact Wrench 9013 SPC

20 3/4"



HAZET No.	■	max. Nm	Air consumption l/min	Working pressure bar	dB(A)	kg
9013 SPC	20 3/4"	1490	176	6.3	Lp A 103.1	5.4

### 6-Point Impact Sockets 903 SPC/3 / 903 S Lg-22

125 1/2"

Made in Germany



HAZET No.	■	Sizes
903 S Lg-22	125 1/2"	s 22 mm e.g. OPEL Insignia
903 SPC/3	125 1/2"	s 17 19 21 mm

DESIGN NEW GENERATION NEW DESIGN

### Air Ratchet 9020-2 / 9021-3

6.3 1/4"



HAZET No.	■	max. Nm	Air consumption l/min	Working pressure bar	dB(A)	kg
9020-2	6.3 1/4"	35	180	6.3	Lp A 83	0.75
9021-3	10 3/8"	35	180	6.3	Lp A 83	0.75

### High Quality Air Ratchet 9021 P-1 10 3/8" / 9022 P-1 125 1/2"

- Also suitable for application in industrial production
- For hand retightening with torque values: 9021 P-1 > 20 % above DIN, 9022 P-1 > 350 Nm (competitive product with approx. 250 Nm)



HAZET No.	■	max. Nm	Air consumption l/min	Working pressure bar	dB(A)	kg
9021 P-1	10 3/8"	95	77	6.3	Lp A 103.9	1.38
9022 P-1	125 1/2"	95	77	6.3	Lp A 99.3	1.39

### Air Ratchet 9022-2 / 9022-3

125 1/2"



HAZET No.	■	max. Nm	Air consumption l/min	Working pressure bar	dB(A)	kg
9022-2	125 1/2"	70	180	6.3	Lp A 88	1.49
9022-3	125 1/2"	110	180	6.3	Lp A 89	1.49

### Impact Air Ratchet 9022 SR-1

125 1/2"

- For hand retightening with torque values > 270 Nm (competitive product with approx. 250 Nm only)
- Reaction-free



HAZET No.	■	max. Nm	Air consumption l/min	Working pressure bar	dB(A)	kg
9022 SR-1	125 1/2"	102	113	6.3	Lp A 98	1.28



### Air Drill 9030-1

- Quick-change chuck, capacity 1–10 mm

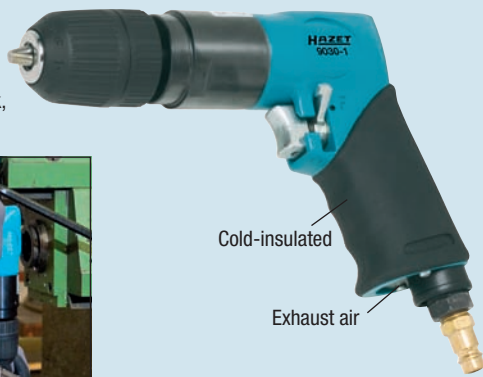

HAZET No.	1/min	Coupler plug nominal size	Air consumption l/min	Working pressure bar	dB(A)	kg	l mm
9030-1	2,600	7.2	113	6.3	Lp A 91	1.3	170

### Die Grinder 9032-1 / 9032-5

9032-5  
Angled design

- Speed regulation with setting wheel
- Collet chuck: 6 mm

9032-1  
Straight design



HAZET No.	1/min	Coupler plug nominal size	Air consumption l/min	Working pressure bar	dB(A)	kg	l mm
9032-1	2,000–25,000	7.2	113	6.3	Lp A 91	0.64	158
9032-5	2,000–22,000	7.2	113	6.3	Lp A 90	0.77	160

### Orbital Sander 9033-2

- With dust collector
- Suction hose and dust collector included
- Continuous speed regulation
- Stroke: 5 mm
- Low height and light composite housing
- Grinding disc with 15 bore holes, Ø 150 mm with hook and loop fastener



HAZET No.	1/min	Coupler plug nominal size	Air consumption l/min	Working pressure bar	dB(A)	kg	l mm
9033-2	12,000	7.2	56	6.3	Lp A 88.8	1.85	230

### Belt Sander 9033-4

- Three abrasive belts included 330 x 10 mm (grain size 80, 100, 120)
- For narrow surfaces (belt width 10 mm)
- Locking device for quick belt changing
- Continuous speed regulation



HAZET No.	1/min	Coupler plug nominal size	Air consumption l/min	Working pressure bar	dB(A)	kg	l mm
9033-4	18,000	7.2	240	6.3	Lp A 73	1.12	335

### Multi Sander Set 9033-6

#### Contents:

- Multi Sander, 2 Erasers
- 1 Adapter for eraser
- 1 Wire brush each, 23 mm Ø and 11 mm Ø coarse and bent
- 6 Eliminator discs
- 1 Wire Brush each 11 mm Ø and 23 mm Ø fine and straight
- 1 Adapter for 11 mm Ø wire brush
- 1 Adapter for single strip wheel
- 1 Adapter for double strip wheel



HAZET No.	1/min	Coupler plug nominal size	Air consumption l/min	Working pressure bar	dB(A)	kg	l mm
9033-6	3,500	7.2	113	6.2	Lp A 88	1.10	318

### Angle Grinder 9033-8

- Including cut-off wheel 100x0.8x9.53 (3/8") mm



HAZET No.	1/min	Coupler plug nominal size	Air consumption l/min	Working pressure bar	dB(A)	kg	l mm
9033-8	16,000	7.2	113	6.2	Lp A 102.3	1.80	400

### Accessories 9033-08/5

- According to European standard 12413 and OSA directives
- 5 Cut-off wheels 100x0.8x9.53 (3/8") mm



### Mini Polisher Set 9033-9

- Incl. Polishing Wheel:  
75 mm Ø

**Contents:**

- 1 Polisher
- 1 Wet grinding pad
- 1 Plastic pad (yellow), soft
- 1 Plastic pad (white), hard
- 1 Lambskin
- 1 Adjusting Wrench



HAZET No.	1/min	Coupler plug nominal size	Air consumption l/min	Working pressure bar	dB(A)	kg	l
9033-9	2,500	7.2	113	6.3	LpA 81	1.96	130

### Sabre Saw 9034-1

- For one-hand operation
- Adjustable support frame, suitable for double-walled sheet steel
- Suitable for cutting small radii
- Free speed strokes/min: 9,500
- With 3 saw blades
- Cutting capacity:  
sheet steel 2.9 mm  
aluminium 3.2 mm

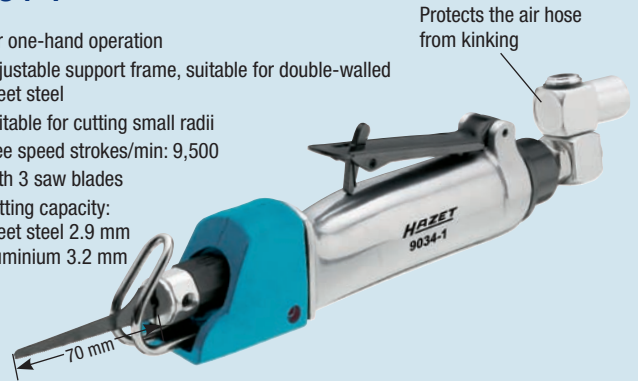

HAZET No.	Coupler plug nominal size	Air consumption l/min	Working pressure bar	dB(A)	kg	l
9034-1	7.2	170	6.3	LpA 90	0.75	215

### Pneumatic Windscreen Removal Tool Set 9034-2/9

- Set of 5 blades included
- Made in Germany



HAZET No.	1/min	Air consumption l/min	Working pressure bar	dB(A)	kg	l
9034-2/9	20,000	370	6.3	LpA 86.7	2.3	180

### Needle Scaler 9035-5

- Adjustable needle cover
- L 330 x W 45 x H 205 mm



HAZET No.	Coupler plug nominal size	Air consumption l/min	Working pressure bar	dB(A)	kg	Impacts/min
9035-5	7.2	170	6.3	LpA 97	3.0	3,200

### Chisel Hammer Set 9035/6

- For detaching car body sheets and for industrial application
- Power control with push-button
- 5 x

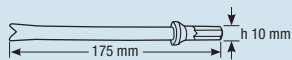

HAZET No.	Coupler plug nominal size	Air consumption l/min	Working pressure bar	dB(A)	kg	Impacts/min
9035/6	7.2	240	6.3	LpA 98	3.25	3,000

### Blind Rivet Gun 9037 SPC / 9037-2

- Pneumatic-hydraulic
- For pop rivets
- Possible rivet sizes 9037 SPC:  
2.4 3.0 3.2 4.0 4.8 mm
- Possible rivet sizes 9037-2:  
2.4 3.2 4.0 4.8 5.6 6.4 mm
- 4 nose pieces (9037 SPC),  
6 nose pieces (9037-2)



HAZET No.	Coupler plug nominal size	Tractive Power N	Air consumption l/stroke	Working pressure bar	dB(A)	kg
9037 SPC	7.2	8,700	1.0	6.3	Lp A 85	1.84
9037-2	-	13,847	1.8	6.3	Lp A 73.3	2.64



### Air Blow and Suction Gun 9043-10



Special bag insert protects the bag against damage (e. g. swarfs)

HAZET No.	Coupler plug nominal size	Air consumption l/min	Working pressure bar	dB(A)	kg	l
9043-10	7.2	96	6.3	Lp A 92	0.67	145

### Pocket Blow Pen 9040-3

- With clip for fixation
- Turn to adjust air flow



### Air Blow Gun 9040-4

- Choice of air supply at tool head or handle
- Pressure regulator
- Exchangeable nozzles (steel)
- Short nozzle for areas with restricted access
- Aluminium housing

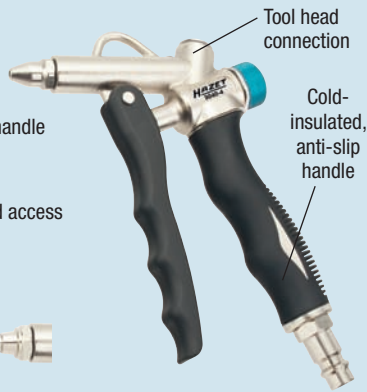

Safety nozzle tip (with scratch protection)

HAZET No.	Coupler plug nominal size	Air consumption l/min	Max. pressure bar	Working pressure bar	dB(A)	kg
9040-4	7.2	330	10	6.3	86	0.2

### Air Hose Reel 9040-10

- Suitable for compressed air or cold water
- Automatic stop: every 50 cm (can be switched off)
- Max. working pressure: 15 bar
- Temperature range: - 5 / + 40 C
- Dimensions (packed): 500 x 450 x 255 mm



### Tire Inflator 9041-1

- Special rubber housing protects manometer against light impacts
- Handle with operating lever and discharge knob, tube with plug-in nipple
- Max. pressure: 8 bar

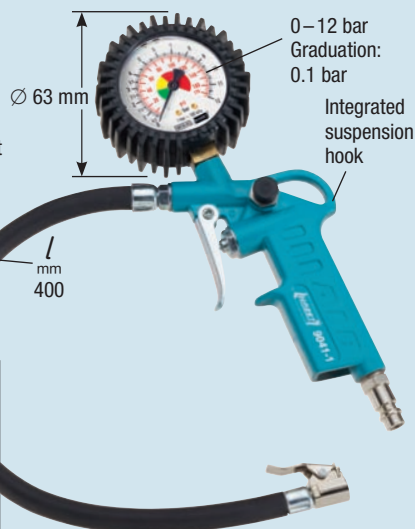

### Tire Inflator, calibrated 9041-2

- Special rubber housing protects manometer against light impacts
- Temperature range: -10° C up to +40° C
- Tube with plug-in nipple

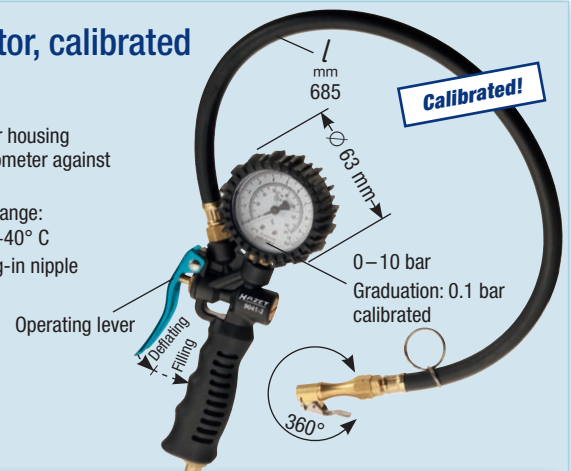

HAZET No.	Description
9041-2	Tire Inflator, calibrated
9041-2CERT	Like 9041-2, but with calibration certificate



### Grease Gun 9042 N-1

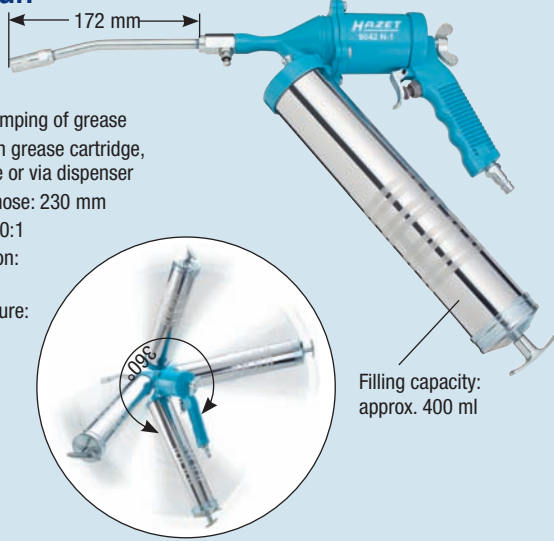

- Continuous pumping of grease
- Gun-filling with grease cartridge, "loose" grease or via dispenser
- Length nylon hose: 230 mm
- Compaction: 40:1
- Air consumption: 230 l / min.
- Working pressure: 6.3 bar
- ⚖️ 2 kg



### Mini Oiler 9070-1

- For oiling automatically
- Refillable, filling capacity 28 ml

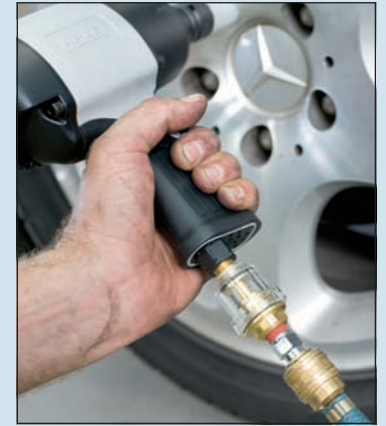

### Magnetic Holder 9070-10

- With two strong magnets to hold 1 impact wrench and 4 sockets

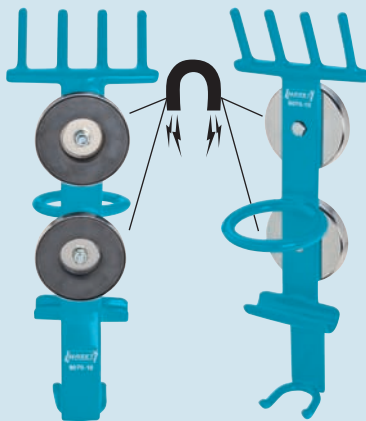

### Hot-Air Tool 1990-1/3

- Power: 1,600 Watts
- 2 temperature ranges 350 / 500 °C
- 2 air flow ranges: 350 / 500 l/min
- ⚖️ 0.68 kg



### Cordless Impact Wrench Set 9212 N-1

12V 1/2"



- Max. torque 540 Nm
- Rotation speed 0–1650 rpm
- Battery pack 3 Ah ~ 18 V
- ⚖️ 2.64 kg

#### Contents:

- Cordless Impact Wrench
- Lithium-Ion Battery Pack
- Battery charger



HAZET No.	Description
9212 N-1	Cordless Impact Wrench Set, 3 pieces
9212 N-01	Battery Pack, Lithium-Ion 3 Ah ~ 18 V
9212 N-1/4	Cordless Impact Wrench Set + additional battery pack

### Spiral Hose 9040-7

- Polyurethan
- Air connection: 6.3 mm (1/4")
- Length: 7.62 m
- Connecting pieces with 360° swivel joints
- Burst pressure according to DIN: 55.1 bar / 800 PSI
- Working pressure: 10 bar
- ⚖️ 630 g

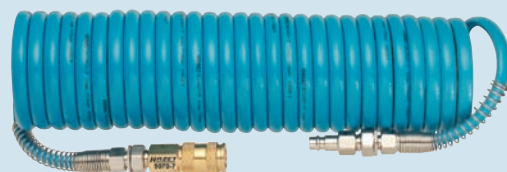



### Motor Sports Longsleeve-Shirt CL4523

- Material: 100% cotton
- With original logos of PORSCHE motor sports and Nürburgring
- 



HAZET No.	
CL 4523-M	M
CL 4523-L	L
CL 4523-XL	XL
CL 4523-XXL	XXL

### HAZET-Motor Sports Polo-Shirt WW4515

- Material: 100% cotton
- 

### HAZET T-Shirt WW4514

- 



HAZET No.	
WW 4515-S	S
WW 4515-M	M
WW 4515-L	L
WW 4515-XL	XL
WW 4515-XXL	XXL

HAZET No.	
WW 4514-S	S
WW 4514-M	M
WW 4514-L	L
WW 4514-XL	XL
WW 4514-XXL	XXL

### Universal Fender Cover 196-1



Made in Germany

### Fender Cover 196-2

- Made of especially coated anti-slip material
- Waterproof, oil and grease repellent
- Cover adheres vertically to almost all car body surfaces
- Fire safety corresponds to British and US standards Fed 302



### Car Cover 196-3

- Also suitable for car repair with the engine running
- Waterproof, oil and grease repellent
- Easy to clean
- Fire safety corresponds to British and US standards Fed 302

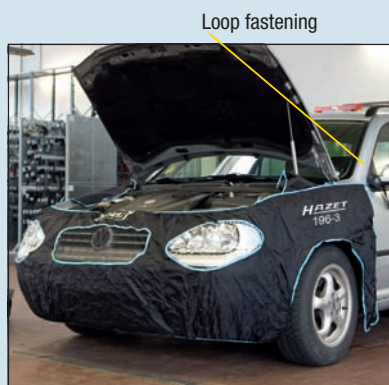

### Steering Wheel and Seat Cover Set 196-6/2

- One size only
- Waterproof, oil and grease repellent
- Tested with a side airbag
- Antistatic
- Fire safety corresponds to British and US standards Fed 302



### Gloves 1987-3

- With hook and loop fastener



**TOPSELLER!**

### Gloves 1987-4

- With micro-foam coating
- Breathable
- Maximum flexibility and freedom of movement together with excellent mechanic protection
- Water repellent



### LED Work Light 1979-6



- Dimensions:  
light: H 295 x W 57 x D 54 mm  
battery charger:  
H 70 x W 138 x D 127 mm
- With adjustable hook
- 1100 g (complete, gross) / 480 g (lamp only)
- Battery pack:  
NiMH rechargeable battery  
4.8 V, 2500 mAh  
2.5 h charging time



3 h, 360 Lumen, 3.5 W  
chip-on-board LED = 150 LED

Replaceable



IP 65

Soft-touch switch

= Charging process



IP 20

### Double-Bar LED Light 1979-60

- Including 220 V and 12 V charging cable
- Multifunction key allows switching between individual and double light
- Rechargeable 2200 mAh Li-Ion battery pack, 5 hours charging time



5 h, 220 Lumen

36 High-Power LED

Swivelling and rotating LED bars

360°

Dimensions: Ø 70 mm x 400 mm, folded out: W 500 mm

360°

### LED Folding Light 1979-61

- Up to 50% lighter than existing lights on the market
- 2 light intensity settings (100% und 50% brightness)
- Rechargeable
- Including 220 V charging cable 5 hours charging time



360°

Light head foldable through 180°

6 h, 110 Lumen

18 LED

Dimensions:  
H 155 x W 55 x D 35 mm  
folded out: H 275 mm



### Kneeling Mat / Mechanic's Mat 195-1 / 195-5

- Easy-to-clean surface

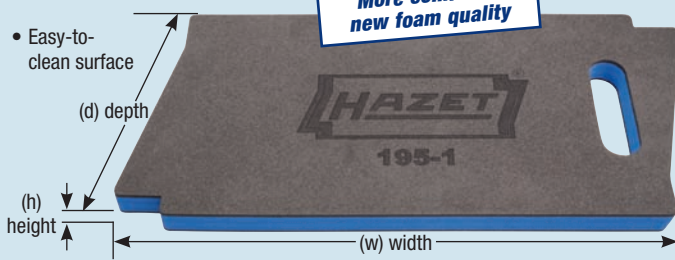

**HAZET**  
No.

Description

195-1	Kneeling Mat H 30 x W 450 x D 210 mm
195-5	Kneeling Mat H 30 x W 975 x D 385 mm

### Pneumatic Chair 195-4

- 5 castors (approx. 60 mm Ø)
- ⚖️ 6 kg



### Mechanic's Creeper 195-2

- 6 castors (70 mm Ø)
- ⚖️ 4.6 kg



### Creeper 195-3

- 6 castors (63 mm Ø)
- ⚖️ 9 kg

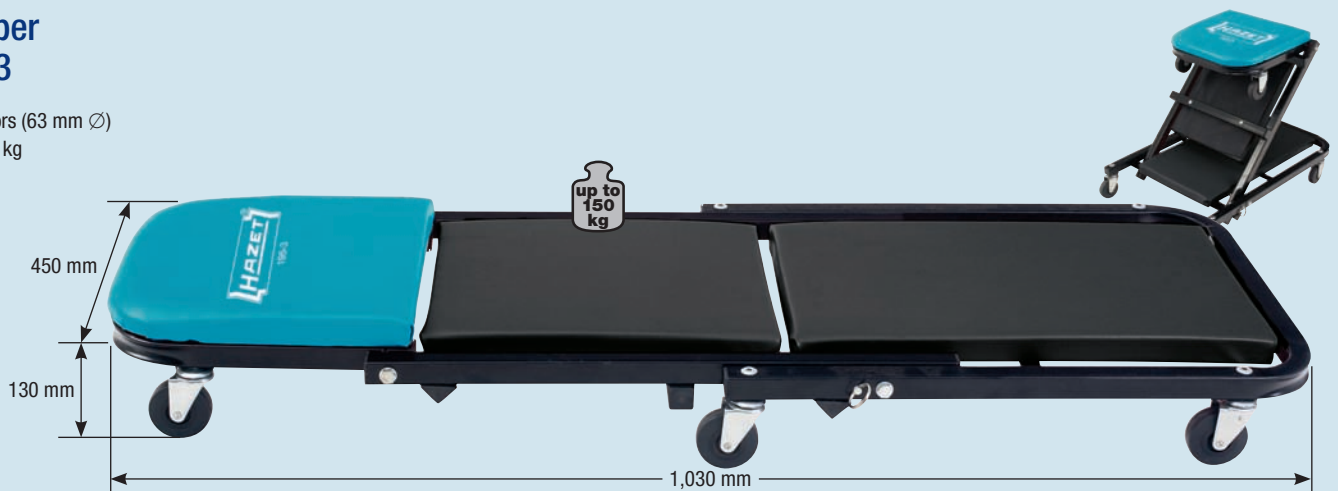

### Multifunctional Drain Pan 197-1 / 197-2

- Safe outpour due to circumferential overflow gutter and pouring spout (197-1) or tap (197-2)

197-1  
Multifunctional Drain Pan



197-2  
Multifunctional Drain Pan



### Magnetic Cup 197-3

**Topseller**

- 150 mm Ø
- Holds small parts



### Flex Spout Funnel 198-1

- Funnel made of polypropylene, flexible spout made of polyethylene, with stainless steel filter



### Engine Oil Filling Funnel 198-2

- Universal use e.g. on AUDI, VW, SEAT, SKODA, MERCEDES-BENZ
- Ensures a direct and tight connection to the oil filling neck at the engine
- Controlled oil-filling (≤ 2.3 l)



### Flexible Funnel 198-3

- Resistant to e.g. gasoline, diesel, oil, coolant, hydraulic and brake fluid



Flexible, shapeable at ease

### Measuring Cup 198-4 – 198-8

- Suitable for non-acidiferous liquids
- Material: HDPE



HAZET No.	Contents
198-4	1 litre
198-5	2 litre
198-6	5 litre with pouring spout
198-8	5 litre



### Nozzle Adjusting Tool 4850-1

- For adjusting the nozzles of the washing system
- The telescopic handle can be used to demonstrate the jet of the nozzles to the window
- With magnetic head 6 mm Ø, adjusting needle, protective cap

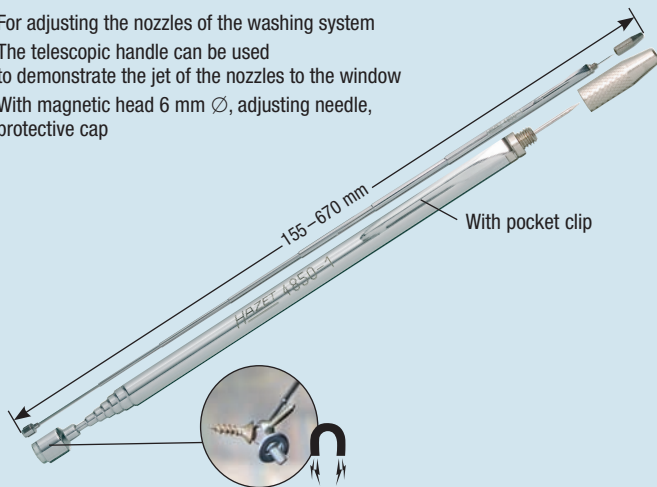

### Protection Caps for Lubricating Nipples, cone type 2162-02/100



### Non-Contact Infrared Thermometer 1991-1

- Non-contact temperature measurements through built-in laser pointer
- Rapid detection function
- Precise non-contact measurements
- Automatic Data Hold
- Max. temperature displays, trigger lock
- 9V block battery (6 LR61)
- Temperature range: -50° C → 550° C; -58° F → 1022° F



### Grease Gun 2162-1 / 2162-2

- Capacity: 500 cm<sup>3</sup>
- With reinforced hose, nozzle tube and 2 nozzles M 10 x 1

2162-1  
Grease Gun  
(light design)

2162-2  
Grease Gun  
(heavy design)



### High Performance Suction Gun 2162-4 / 2162-6

- Spare material may be easily sucked back
- Incl. metal outlet and flexible plastic hose outlet
- Housing made of galvanized steel

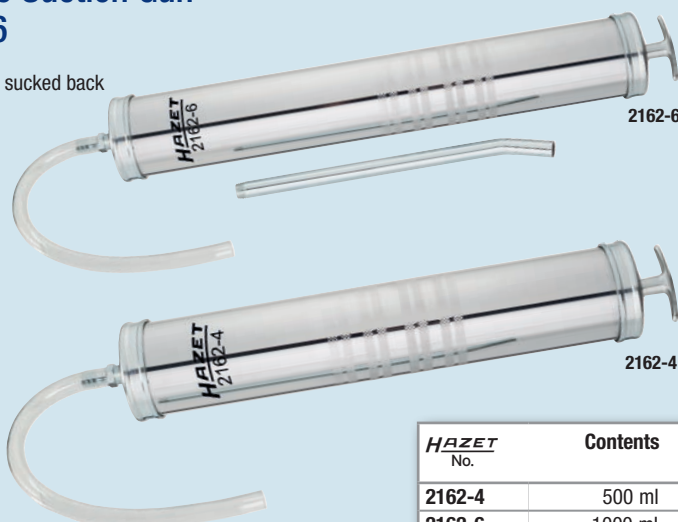

HAZET No.	Contents
2162-4	500 ml
2162-6	1000 ml



## Hand Pump with Telescopic Suction Tube 2163-1

- Suitable for drums from 50 to 200 l
- Telescopic suction tube made of metal, extendable from 450 to 860 mm
- Base component made of galvanised steel
- R 2" and R 1½" drum adapters
- Removable, bent outlet made of metal
- Flow rate: approx. 0.35 l / stroke
- ⚖️: 2.2 kg
- **Caution:**  
Not suitable for gasoline extraction

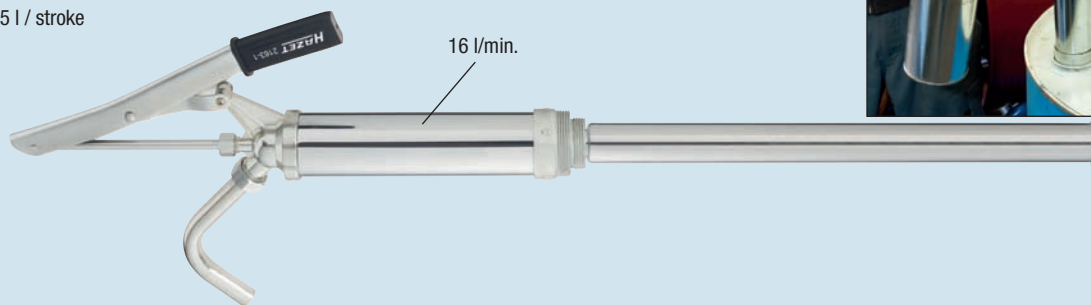

## Hand Sprayer 199-1

- Especially for the application of chemical products and those that are highly corrosive
- For lubrication of workpieces and for application in landscaping and gardening
- Integrated safety valve (3 bar)
- Viton® gaskets
- Replacement kit with 2 nozzles
- ⚖️: 0.3 kg



H 265 mm x W 165 mm

## Spraying Machine 199-2

- Especially for the application of chemical products and those that are highly corrosive.
- Integrated safety valve (3 bar) with decompression function
- Openable under pressure
- Viton® gaskets
- Lance is connected to the tank
- Replacement kit with 2 nozzles as well as additional hose for acids
- With integrated filter for suspended particles
- ⚖️: 1.65 kg



Gross volume: 9 l  
(net volume: 6 l /  
pressure storage: 3 l)

H 520 mm x W 200 mm

## Telescopic Inspection Mirror Set 1977-2/4

- Double hinge joint with tension spring

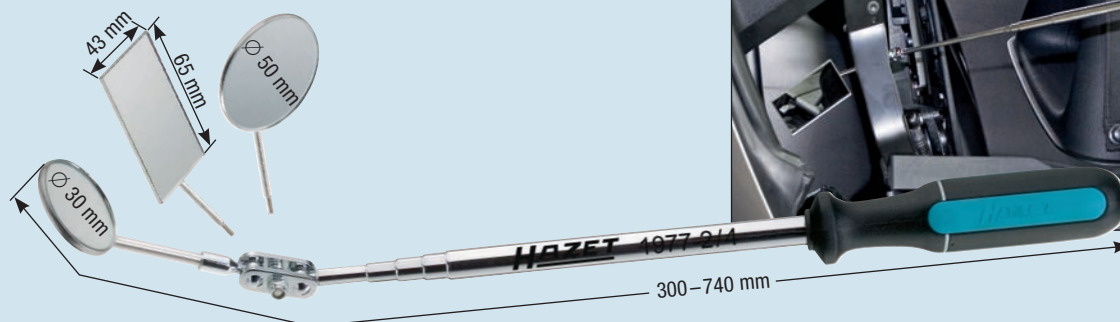



### Carbon-Steel all-purpose Household Knife 2156-18



### Jack-Knife (Universal Knife) 2157-1 / 2157-2

- Quick blade changing
- With 5 spare blades



HAZET No.	Description	l mm	⚖ g
2157-1	Jack-Knife	155	140 g
2157-2	Mini Utility Knife	100	40.6 g

### Hearing Protection Band 1984-1 / 1984-01/10

- Offset band prevents the ear plugs from getting soiled when taking it off
- Easy replacement of ear plugs (1984-01/10)

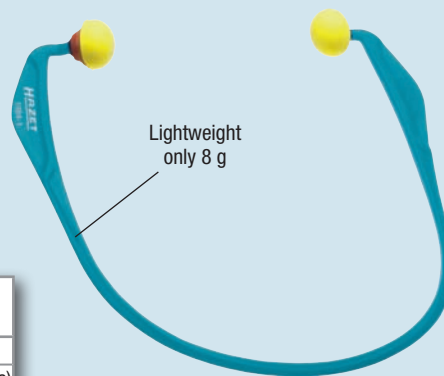

HAZET No.	Description
1984-1	Hearing Protection Band
1984-01/10	Replacement Ear Plugs (10 pieces)

### Safety Glasses 1985 SPC – 1985-5

- Extremely scratch resistant, optimal fit, protection for grinding, lathing and milling work etc.
- Sporty design
- Durable anti-fog coating



HAZET No.	Description
① 1985 SPC	Grey polycarbonate lens UV 5-2.5 DIN EN 166-168
② 1985-1	Colourless polycarbonate lens UV 2-1.2 DIN EN 166-168, UV 400 Made in Germany
③ 1985-5	Colourless polycarbonate lens UV 2C-1.2; Supravision NC coating (outside optidur NC / inside optidur 4C Plus) Made in Germany



## Engine Timing Tools

### Universal Engine Timing Tool Set 4794/35

- For petrol and diesel engines, e.g. on **VW, AUDI, SEAT, SKODA, FORD, OPEL, CITROËN, PEUGEOT, RENAULT**
- Mandrels and tools for locking of crankshaft and camshaft during timing belt replacement



### Others



**BMW**





**OPEL**



**FIAT**

**VW  
AUDI  
SEAT  
SKODA  
ALFA**

HAZET No.		Description
2588/9	9	<b>VW/AUDI/SEAT/SKODA</b> Set for petrol and diesel engines Supplement for <b>2588/19</b>
2588/19	19	<b>VW/AUDI/SEAT/SKODA</b> Set for petrol and diesel engines
2988/7	7	<b>BMW</b> Set for petrol engines
2988/11	11	<b>BMW</b> Set for petrol engines
2988/13	13	<b>BMW</b> Set for diesel engines
2988/18	18	<b>BMW</b> Set for petrol engines
2988/25	25	<b>BMW</b> Set for petrol engines comprising <b>2988/7</b> and <b>2988/18</b>
3088/19	19	<b>OPEL/VAUXHALL</b> Set for petrol and diesel engines
3088/7	7	<b>OPEL</b> Supplement for <b>3088/19</b>

HAZET No.		Description
3488/8	8	<b>FORD</b> Set Supplement for <b>3488/17</b>
3488/17	17	<b>FORD</b> Set for petrol and diesel engines
3688/20	20	<b>FIAT</b> Set for petrol and diesel engines
3690/6	6	<b>ALFA ROMEO</b> Set for petrol engines
3788/37	37	<b>PSA CITROËN / PEUGEOT</b> Set for petrol and diesel engines
3888/8	8	<b>RENAULT</b> Supplement for <b>3888/19</b>
3888/19	19	<b>RENAULT</b> Set for petrol and diesel engines
4794/5	5	<b>Universal Tool</b> Set for petrol and diesel engines
4794/48	48	<b>Universal Tool</b> Set
4794/35	35	<b>Universal Tool</b> Set for petrol and diesel engines

For further engine timing tool sets and detailed descriptions see HAZET Illustrated List 2013, from page 192 or on [www.hazet.de](http://www.hazet.de).



### Engine Timing Tool VW 1.2 TFSi with Timing Chain 2588-1/4



- For checking and adjusting of engine timing
- For **AUDI** A1, A3, **SEAT** Altea/XL, Ibiza, Leon, **SKODA** Fabia II, Octavia II, Roomster, Yeti, **VW** Caddy, Golf, Golf Plus, Jetta, Polo, Touran
- May be stored in case 2588/19

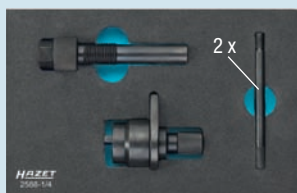

1/9

1 x 2588-20	Camshaft locking pin
1 x 2588-21	Crankshaft locking pin
2 x 2588-22	Locking pins, pairs

(without SmartCase)

### Engine Timing Tool VW T4, LT Diesel Engine 2588-2/5



- For timing belt replacement and other engine repairs
- Easy to follow instructions including cross references to original part numbers
- Individual parts are available as an option
- For **VW** Transporter T4 (1990–2003), LT (1996–2006), Crafter (2006–)
- May be stored in case 2588/19

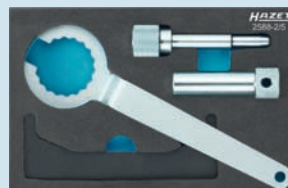

1/9

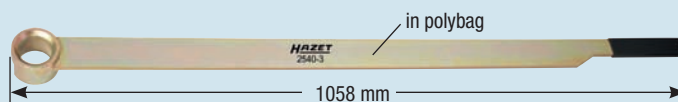

1 x 2540-3	Counterholder
1 x 2588-7	Marking mandrel
1 x 2588-5	Camshaft setting plate
1 x 2587-32	Tension roller actuator
1 x 2588-28	Marking mandrel

(without SmartCase)

### Engine Timing Tool VW FSi, TFSi, 2,0 16V 2588/7



- For checking and adjusting of engine timing
- For **AUDI** A3 (2003–2010), A4 (2002–2010), A6 (2005–2010), TT (2006–2010), **SEAT** Leon (2005–2010), Toledo (2004–2009), Altea/XL (2005–2009), Exeo (2009–2010), **SKODA** Octavia II (2004–2009), **VW** Golf (2004–2010), Golf Plus (2005–2009), Jetta (2005–2009), Eos (2006–2010), Touran (2003–2009), Passat (2005–2010)

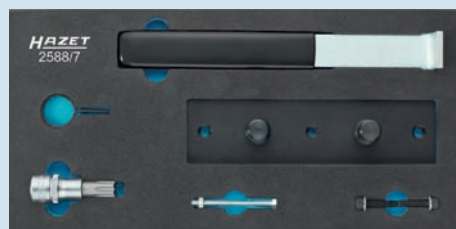

1/3

1 x 2588-27	Bolt and Nut
1 x 2588-23	Camshaft positioner, 3 pieces
1 x 2579-9K	Cam phaser socket
1 x 2588-26	Camshaft positioner
1 x 2588-8	Locking Pin

(without SmartCase)

### Engine Timing Tool VW 2.5 l diesel engine 2588/10



- For **VW** Touareg (2003–2008), T5 Transporter (2003–2008), Multivan (2004–2008)
- Easy to follow instructions including cross references to original part numbers
- Single parts optionally available



1/3

1 x 2588-29	Adjustment disc for crankshaft with allen screw, 2 pieces
1 x 2588-30	Crankshaft locking with 2 marking mandrels, 4 pieces
1 x 2588-31	Camshaft Setting Tool
1 x 2588-32	Camshaft clamp
1 x 2588-33	Eccentric wrench
1 x 2588-34	Adjusting tool for camshaft

(without SmartCase)

## Engine Timing Tool FORD / MAZDA / VOLVO 3488/5



- For checking and adjusting of engine timing
- For **FORD** Fiesta (1995–2009), Fusion (2002–2009), Puma (1997–2002), Focus (1998–2009), Focus C-Max (2003–2007), C-Max (2007–2009), Mondeo (1993–2009), Cougar (1998–2001), S-Max (2006–2009), Galaxy (2006–2009), Tourneo Connect (2002–2006), Transit Connect (2002–2006), Transit (2006–2009), **MAZDA** 121 (1995–2000), 2 (2002–2007), 3 (2003–2009), 5 (2005–2009), 6 (2002–2009), MX-5 (2005–2009), MPV (2002–2005), Tribute (2001–2004), **VOLVO** S40/V50 (2004–2009), C30 (2006–2009)
- May be stored in case 3488/17

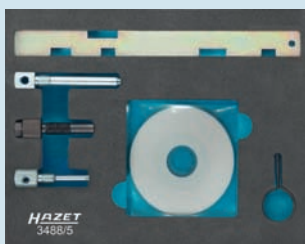

1 x 3488-13	Camshaft setting plate
1 x 3488-10	Crankshaft locking pin
1 x 3488-11	Crankshaft locking pin
1 x 3488-15	Crankshaft locking pin
1 x 2588-8	Locking pin for tension roller

## Engine Timing Tool CITROËN / PEUGEOT / MINI 3788/9



- For checking and adjusting of engine timing
- For **CITROËN** C4 (2008–), C4 Picasso (2008–), **PEUGEOT** 207 (2006–), 207CC (2007–), 308 (2007–), **MINI** MINI One R56 (2007–), Cooper R55/R56 (2006–), Cooper S R55/R56 (2006–)



1/3

1 x 3788-34	Locking Pin, bent
1 x 3788-35	Camshaft setting plate, 4 pieces
1 x 3788-36	Camshaft Setting Plate
1 x 3788-37	Camshaft setting plate, 2 pieces
1 x 2988-22	Chain Tensioner

(without SmartCase)

## Timing Belt Locking VW / AUDI / SEAT / SKODA / FORD 2588/3



- For timing belt replacement, e.g. of **VW** engines with pump-nozzle injection technology since 1999
- For e.g.: **AUDI** A2, A3, A6, **VW**-Passat, Golf, Bora, Beetle, Sharan, Lupo and Touran, **SEAT** Alhambra, Arosa, **SKODA** Octavia, Fabia, Superb, **FORD** Galaxy



2588-1  
Crankshaft-stop

2588-2  
Locking plate

2588-3  
Marking mandrel

## Crankshaft Fixing Device VW / AUDI / SEAT / SKODA 2588-110

- For **VW, AUDI, SEAT, SKODA** 4 cylinder diesel engine, engines with pump-nozzle injection technology since 2005
- For locking the oval timing belt pulley of the crankshaft



## Vacuum Radiator Filling Set 4801-1

- Suitable in conjunction with the single and universal adapters of the HAZET range of Cooling System Testers 4800 or with an appropriate rubber cone of the set 4801-2/3
- Vacuum leakage test of radiator before filling
- Bubble-free refilling
- Easy application due to quick-release coupling
- Time-saving, no additional bleeding necessary

Made in Germany



HAZET No.	Description
4801-1	Vacuum-Type Cooling System Filler
4801-2/3	Cone set, 3 pieces, $\varnothing$ 17-31 mm, 24-39 mm, 34-50 mm



### Flexible Hose Clamp Set 4590/3



For heating and fuel hoses  
up to 15 mm Ø

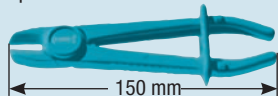

For hoses up to 30 mm Ø

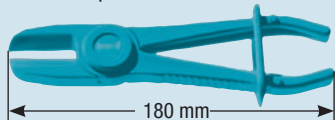

For coolant hoses up to 60 mm Ø

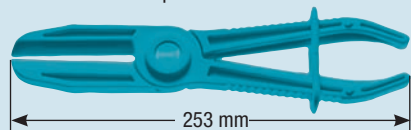

### Injector Extractor 4797/2



- For disassembly of tight common rail injectors without removing the cylinder head, e.g. for **MERCEDES-BENZ** CDI engines 611, 612, 613 etc.
- Germany** Made in Germany

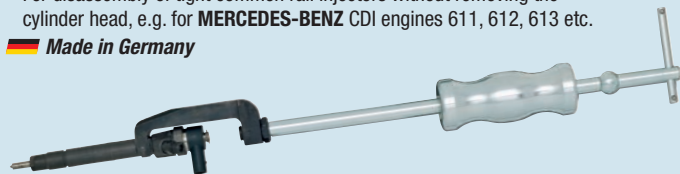

HAZET No.	Description	l mm	Internal and external thread
4797-3	External adapter	50	M 16 x 1.5 to M 27 x 1 mm
4797-4	Injector adapter for <b>VW/AUDI</b> 1.7 SDI, 1.9 TDI, 1.9 SDI engines	44	M 16 x 1.5 to M 14 x 1.5 mm
4797/2	Injector extractor, 2 pieces		

### Tester for Cooling System 4800/12 / 4800/7

**Germany** Made in Germany



Up to 2.5 bar

Applications for all listed radiator adapters are explained in the Illustrated List 2013 on pages 212 and 213.



[www.hazet.de](http://www.hazet.de)  
Additional radiator adapters can be found here  
HAZET Online Catalogue



HAZET No.	Description
4800/7	Radiator tester, 7 pieces, incl. adapter 4800-4A, -6A, -12A, -15, -17
4800/12	Radiator tester, 12 pieces, incl. adapter 4800-3, -4A, -5A, -6A, -7A, -8A, -12A, -13A, -17, -22, -23

### Assembly Tool Set 2536-1/15

- For professional installation of seals, e.g. at crankshafts- or camshafts of most **VW/AUDI** engines

**Germany** Made in Germany

Available in April!



1 x	2536-1	Housing
1 x	2536-2	Support Sleeve
1 x each	2536-3, 2536-4, 2536-5	Pressure ring
1 x each	2536-6, -7, -8, -9, -10	Adapter sleeve
1 x each	2536-11, -12, -13, -14, -15	Centring sleeve in foam insert of plastic case



## Brakes

### Universal Brake Tool Set 4968/14

14

- Assembly, disassembly and cleaning of brakes



1 x Brake calliper brush	
1 x Brake calliper file	
1 x Joint screwdriver socket	s 7 mm
2 x Screwdriver sockets	s 7 mm (short and long)
2 x Screwdriver sockets	s 8 mm (short and long)
2 x Screwdriver sockets	s 9 mm (short and long)
2 x Drift pin	∅ 3 mm (short and long)
2 x Drift pin	∅ 4 mm (short and long)
1 x Screwdriver	PH 3 with striking cap

### Brake Piston Readjusting Set 4970/6

6

Made in Germany



1 x Basic unit 4970-1

1 x Adapter 4970-5

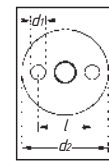

**AUDI** A4 since 2004, A6 since 1997, 100 since 1993, 80, B4, **VW** Golf 4, Golf 5 since 2004, Passat since 2002, Polo since 2004, T4 since 1998, T5 since 2004, **OPEL** Astra GTC since 2005, Zafira since 2000, Zafira since 2007, **FORD** Transit since 2007, **PEUGEOT** 307 SW since 2002, 407, **CITROËN** C4 since 2008, C5 since 2006, Xsara since 2002, **ALFA** 156 since 2004, 147 since 2005–2008, 166 since 2004, **RENAULT** Trafic since 2006, Espace since 2000, **SEAT** Ibiza since 2003, Altea since 2004, Toledo since 2001, **SKODA** Fabia since 2004, **FIAT** Croma since 2006, Croma since 2008 ( $d_1 = 35$ ,  $d_2 = 5$ ,  $l = 29$  mm)

1 x Adapter 4970-6

**VW/AUDI** Allen 12 mm ( $d_1 = 30$  mm)

1 x Adapter 4970-7

**FORD** Focus (-2003), Mondeo since 2001, **OPEL** Zafira, Astra, Astra G, Corsa GSi, **SMART** For Four, **MAZDA** 6 since 2003, **RENAULT** Kangoo 4x4 since 2005, **ALFA** Spider since 1998, **TOYOTA** Corolla since 2000 ( $d_1 = 32$ ,  $d_2 = 6$ ,  $l = 24$  mm)

1 x Adapter 4970-8

**CITROËN**, **VW/AUDI** ( $d_1 = 55$ ,  $d_2 = 6$ ,  $l = 44$  mm)

1 x Adapter 4970-9

**HONDA** Jazz since 2006, **FORD** Mondeo since 2000, Focus since 2004, **SAAB**, **RENAULT** Scénic 2, **ROVER** 214i rear, **VW** GOLF 4, **NISSAN** Almera, **FIAT** Panda 4x4 since 2006, **OPEL** Tigra B since 2007 ( $d_1 = 30$ ,  $d_2 = 5$ ,  $l = 22$  mm)

### Pneumatic Brake Fluid Bleeder Set 4969-1/3

3

- For brake bleeding at wheel brake cylinders / callipers; suitable for ABS system (*Caution: follow manufacturer's instructions!*)
- Transparent brake fluid hose is used for visual inspection
- Integrated Venturi System
- Air consumption: 180 l/min

Working pressure: 6 to 8 bar



### Brake Piston Readjusting Tool 4971-1

Made in Germany





### Tube Flaring Tool Set 2191/12K



- For making open (F) or twin-flares (E) according to DIN 74234, standard 90° and 180° flares
- For metal pipes and lines with 0.7 und 1.0 mm wall thickness, line Ø 4.75–10 mm
- *Caution: for plastic coated brake lines use HAZET 2193/4 K only!*

Made in Germany



### Tube Flaring Tool Set 2193/4K



- Especially for plastic-coated brake lines 4.75 mm Ø

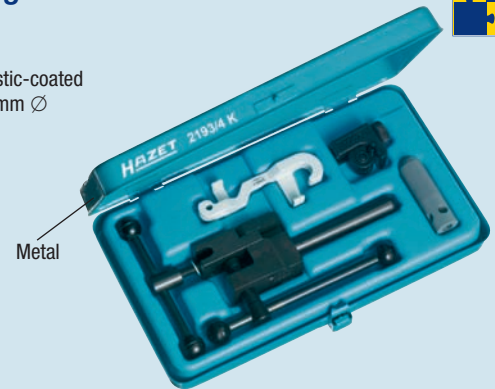

### Exhaust Pipe Cutter 4682 / 4682-1



HAZET No.	Description	l mm
4682	Cutting of pipes made of V2A steel up to 2.5 mm wall thickness and 80 mm Ø	255
4682-1	Cutting of pipes made of galvanized steel, copper, PVC and aluminium up to 6 mm wall thickness and 113 mm Ø	315

### SAC Clutch Alignment Tool Set (3-hole division) 2174-1/34

Made in Germany



### Expansion Set SAC Clutch Alignment Tool (4-hole division) 2174-2/5

- For SAC Clutch Alignment Tool Set 2174-1/34

Made in Germany



## Chassis

### Shock Absorber Tool Set 4910/13

- Counter holder for piston rod during removal and installation of strut
- Caution: follow manufacturer's torque values!

Made in Germany



For additional tools for piston rods see Illustrated List 2013, page 241

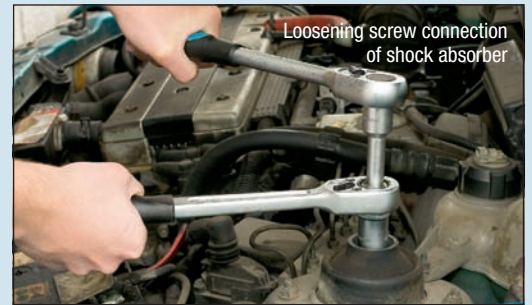

1 x		4910-1
3 x		s 6 7 8 mm
2 x		s 5 x 8 6 x 8 mm
7 x		s 16 17 18 19 21 22 24 mm

### HAZET Safety Spring Vice Set 4900-2 A/5

- Suitable for impact wrenches
- Closed system – maintenance-free!
- Variable system due to easily replaceable tensioning jaws
- 4900-2A is also suitable for struts with buffer spring in the shock absorber!
- With location bar for machinist's vice
- No need of further specialty tools

#### Contents:

- 1 basic unit and 4 clamping plates 2 x 4900-11 each and 4900-12, may be used for ca. 100 different vehicle types

Made in Germany





### Stationary Universal Spring Vice 4903/4

Made in Germany

Load-free! Dismantling

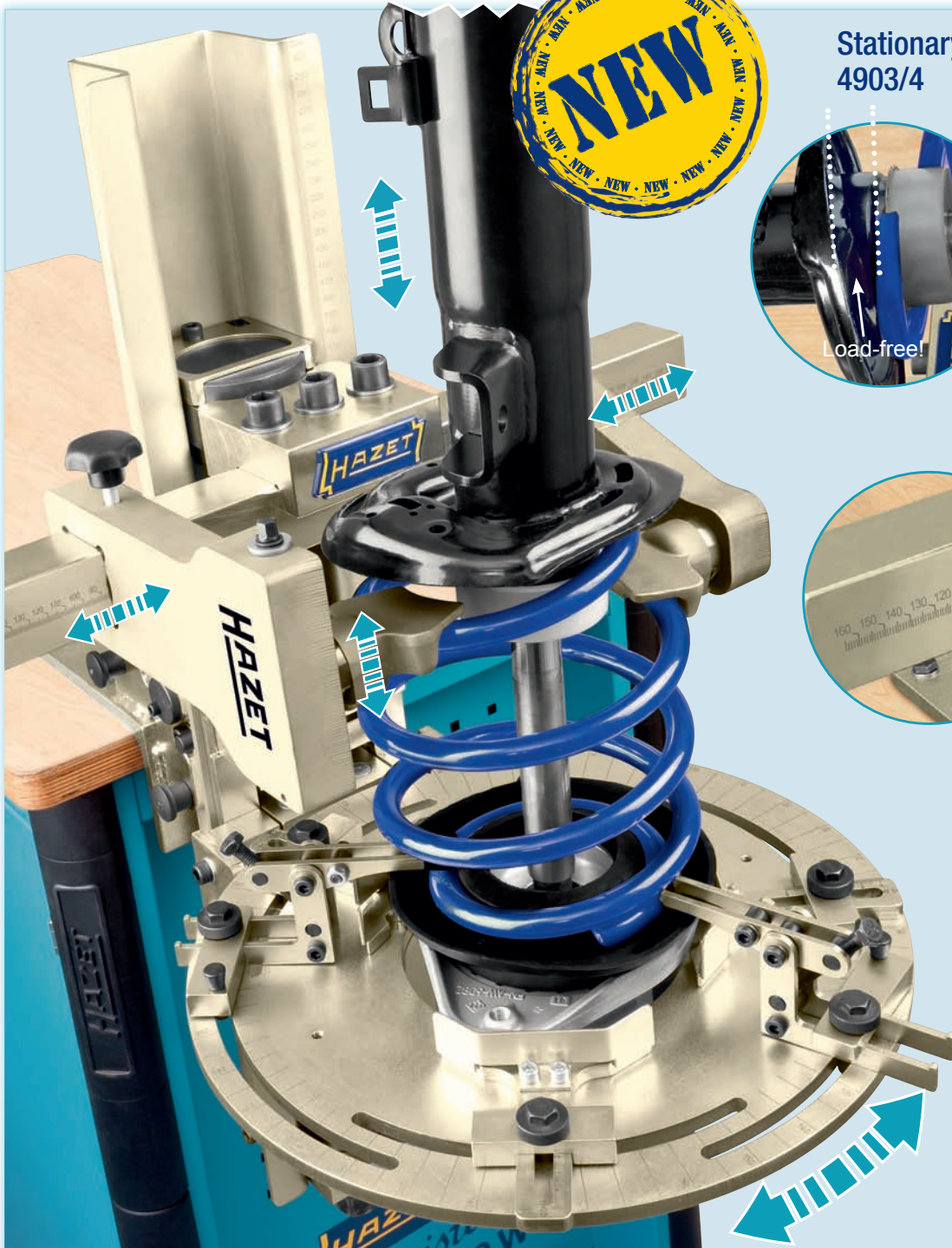
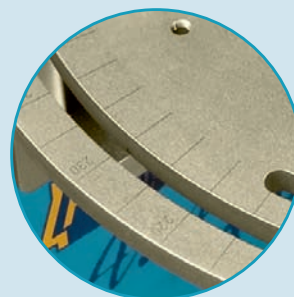
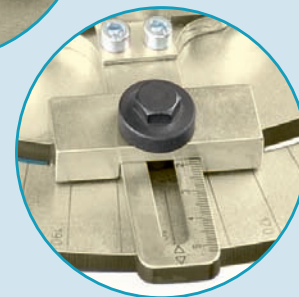
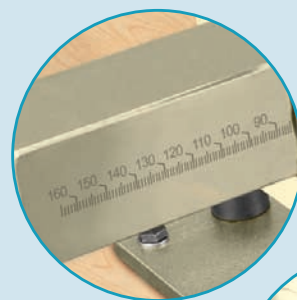

Spring Vice 4903/4

Strut fixation

Swivelling

Optimum working height approx. 1.30 m

Operating

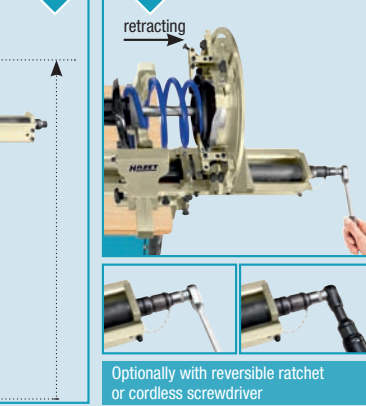
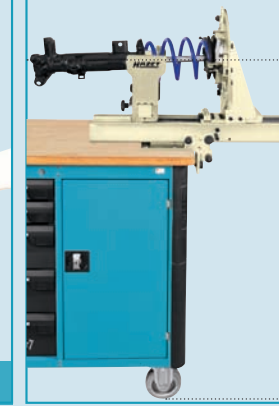
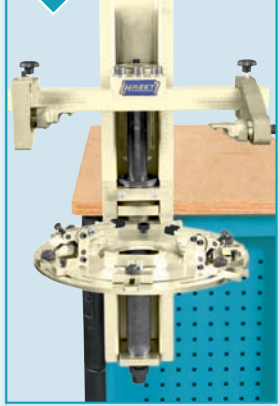



# HAZET Universal Spring Vice

## Increased safety - thanks to load-free installation!



- ✓ Can be used for almost any strut / shock absorber
- ✓ Load-free dismantling / Installation with completely load-free shock absorber
- ✓ Novel seating and assembly concept
  - Swivelling in horizontal or vertical working position, HAZET recommends ergonomic working height: adjust vertically, operate horizontally
  - Damage to shock absorbers and head plates impossible (no overload risk)
  - Simple, lockable strut mount
- ✓ High safety
  - Consistently reliable seating of head plates
  - Thread damage to piston rod impossible
  - Permanent fixation of spring throughout operation
- ✓ Allows record keeping due to scaling
  - If recurring, significant time savings due to scaling
  - Firm fixation eliminates readjustment at the same strut (left / right)
- ✓ Secured investment by using existing components of SYSTEM 4900
  - Existing basic units 4900-2A and all clamping plates of System 4900 may be used
  - Use of future applications is assured

**HAZET Youtube-CHANNEL**  
Video of how to use it  
**4903/4**

**From April!**  
www.youtube.com/HAZETWERK  
4903/4 Universal spring tensioner

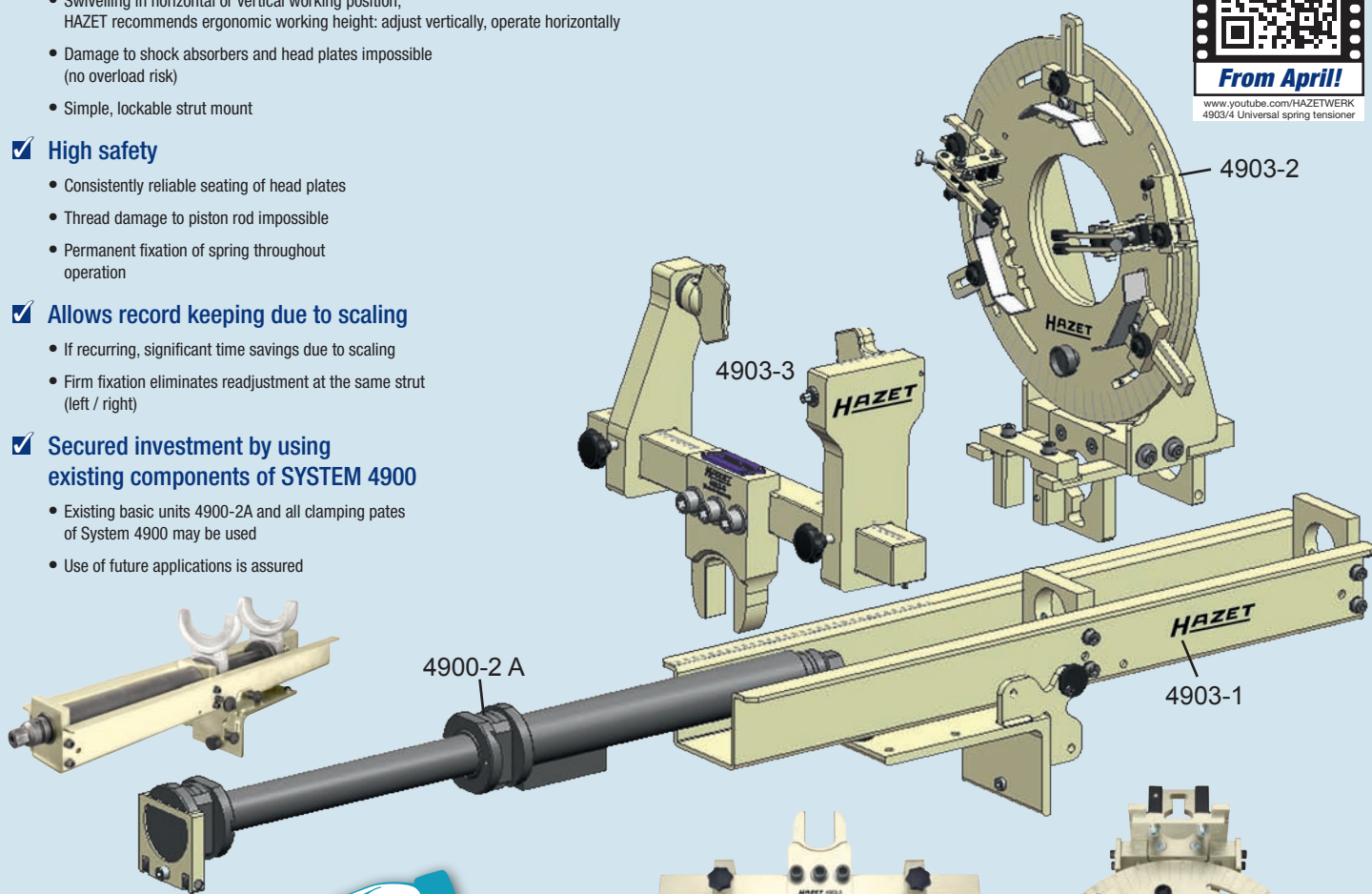

### 4 steps to success



1. Mount strut on clamping disc using gripper and spring-loaded brake
2. Grip spring with universal clamping plate
3. Compress clamps either with reversible ratchet or cordless screwdriver
4. Remove shock absorber load-free and install new one (then reverse order)

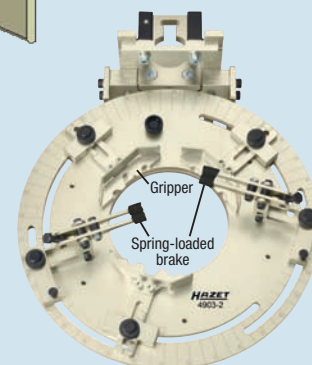

4903-2 Clamping disc (adjustable)

Made in Germany

HAZET No.	Description
4903-1	4903-1
4903/2	4903-2 + 4903-3
4903/2 A	4903-1 + 4900-2 A
4903/3	4903-1 + 4903-2 + 4903-3
4903/4	4903-1 + 4903-2 + 4900-2 A + 4903-3 = all inclusive

**Available in April!**



4900-2 A Basic unit

4903-1 Base support



### Air-Hydraulic Pump 4932-110

- Incl. 2 meter hydraulic hose with connector and 3 meter pneumatic hose
- Max. working pressure: 700 bar
- Air connection, thread: 6.3 mm = 1/4"
- Hydraulic connection: 10 mm = 3/8" - 18 NPTF
- Big pedal: pump, hold, release
- ⚖ 5.3 kg

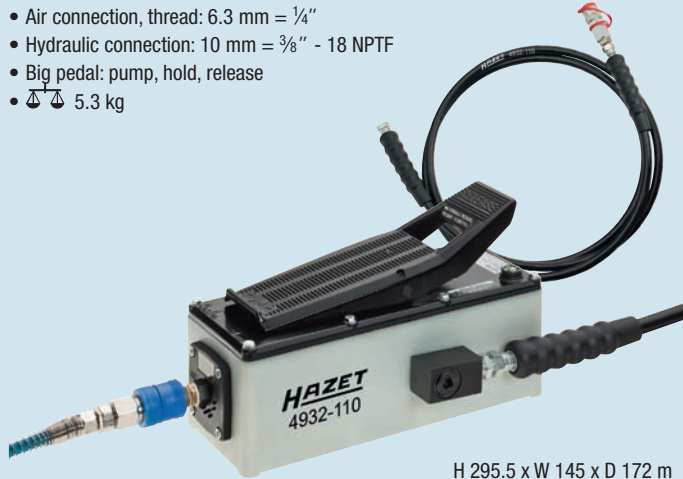

H 295.5 x W 145 x D 172 m

### Hydraulic Foot Pump, mechanical 4932-100 / 4932-101

- Incl. 2 m hydraulic hose with connector
- Max. working pressure: 700 bar, overload protection
- Steel frame for highest stability
- Transport interlock
- Foot-controlled drain valve
- Big pedal
- Piston stroke: 16 mm
- ⚖ 10 kg



Capacity of the tank: 1,000 ml

L 750 x W 230 x H 170 mm

HAZET No.	Description
4932-100	Hydraulic Foot Pump, mechanical
4932-101	High-pressure gauge, 63 to 1000 bar

### HAZET Hollow Piston Cylinder 4932-17

- Incl. adapter for spindle with M20 thread
- Compact 17 t – hydraulic cylinder
- Working pressure: max. 700 bar
- Stroke: 45 mm
- ⚖ 5.5 kg

🇩🇪 Made in Germany



Incl. coupling and protective cap



### Accessory for 4932-17

🇩🇪 Made in Germany



HAZET No.	Description Accessories
4930-721	Housing Ø 72 mm, for product group 4930-1/16 by using 4932-17 with 4932-TR20 and 4930-2
4930-821	Housing Ø 82 mm, for product group 4930-1/16 by using 4932-17 with 4932-TR20 and 4930-2
4930-851	Housing Ø 85 mm, for product group 4930-1/16 by using 4932-17 with 4932-TR20 and 4930-2
4932-M20	Adapter for hollow piston cylinder, M20 thread
4932-TR20	Spindle TR20 for hollow piston cylinder 4932-17
4934-10	Hydraulic pressure disc for 4934-2572/12, -2562/6, -2566/6 by using 4932-17
4934-8510	Hydraulic pressure disc for 4934-2585/12 by using 4932-17

### Bracket 4932-20/2 / 4932-20/3

- Allows considerably higher flexibility and simplification in positioning by 6 axes in total

🇩🇪 Made in Germany

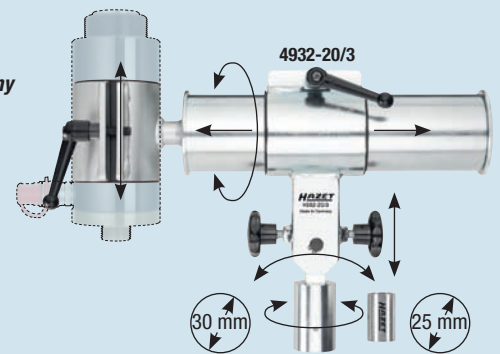

HAZET No.	Description
4932-20/2	Bracket for 4932-17, 4-axis motion
4932-20/3	Bracket for 4932-17 also with extension / deflection, 6 axes



## Wheel Bearing Tool Set VW/AUDI/OPEL/Ford 4930-1/16 / 4930-1/22



- Wheel bearing tool set for mechanical and hydraulic operation
- Hydraulic 4630-1/22 in conjunction with hydraulic cylinder 4932-17 and hydraulic spindle 4932-TR20

Made in Germany



HAZET No.	Description
4930-1/16	Wheel Bearing Tool Set, 16 pieces (mechanical)
4930-1/22	Wheel Bearing Tool Set, 22 pieces (hydraulic / mechanical)

## Compact Wheel Hub / Wheel Bearing Tool Set 4934-3478/11



- Special Tool Set  $\varnothing$  78 mm bearing unit with stud for:  
FORD Focus 2 since 2004, C-Max years 2003–2007 and since 2007  
VOLVO C30 since 2006, C70 2 Cabriolet since 2006, S40 since 2004,  
V50 since 2004, MAZDA 3 (BK) 1.4 1.6 1.6DI Turbo since 2003
- Made in Germany

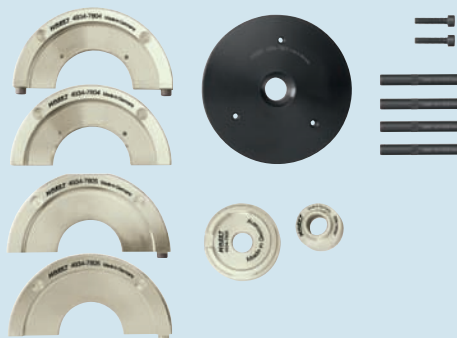

HAZET No.	Description
4934-3482/6	Complete special set $\varnothing$ 82 mm, 6 pieces For FORD Mondeo 4, model year 2007, FOCUS 2 2.5 RS and 2.5 RS 500 since 2007

## Compact Wheel Hub / Wheel Bearing Tool Set 4934-2572/12



- Starter set  $\varnothing$  72 mm, special set  $\varnothing$  85 mm
- For removal and installation of wheel hub bearing unit when installed



HAZET No.	Description Accessories
4934-2572/12	Complete starter set $\varnothing$ 72 mm, 12 pieces For AUDI A2 since 2000, SKODA Fabia since 2000, VW Polo since 2002, Fox since 2005, SEAT Ibiza since 2002
4934-4/3	Components (removal) $\varnothing$ 72 mm, 3 pieces
4934-5/3	Components (installation) $\varnothing$ 72 mm, 3 pieces
4934-2585/12	Complete special set $\varnothing$ 85 mm, 12 pieces For VW T5, Touareg with chassis for 16 inch wheels
4934-8504/3	Components (removal) $\varnothing$ 85 mm, 3 pieces
4934-8505/3	Components (installation) $\varnothing$ 85 mm, 3 pieces
4934-8507	Adapter ring VW T5, supplement for 4934-2585/12

Made in Germany



Made in Germany



4930-2  
Spindle nut s 30 mm

4930-1  
Spindle incl. hexagonal thrust bearing drive s 22 mm

## Compact Wheel Hub / Wheel Bearing Tool Set 4934-2562/6



- Supplementary Set for 4934-2572/12
- For removal and installation of wheel hub bearing unit when installed

Made in Germany

HAZET No.	Description Accessories
4934-2562/6	Complete supplementary set $\varnothing$ 62 mm, 6 pieces For VW Lupo, AUDI A2 1.2 l
4934-6204/3	Components (removal) $\varnothing$ 62 mm, 3 pieces
4934-6205/3	Components (installation) $\varnothing$ 62 mm, 3 pieces
4934-2566/6	Complete supplementary set $\varnothing$ 66 mm, 6 pieces For VW Polo, SKODA Fabia
4934-6604/3	Components (removal) $\varnothing$ 66 mm, 3 pieces
4934-6605/3	Components (installation) $\varnothing$ 66 mm, 3 pieces





### Universal Tool Set for Silent Blocks and Joint Bearings 4926-1/19



- For silent blocks or joint bearings with  $\varnothing$  40–71 mm inner bore:  $\varnothing$  min. 10 mm (for mechanical drive with supplied spindles)
- Also suitable for workshop press
- May be used optionally with hydraulic cylinder 4932-17 in conjunction with adapter 4926-4

**Made in Germany**



### Cardan Shaft Extractor Set 4935-2/15



- For extracting, hydraulic cylinder 4932-17 optionally available
- Suitable for: ALFA ROMEO, AUDI, BMW, CITRÖEN, FIAT, FORD, LADA, LANCIA, MERCEDES-BENZ, OPEL, PEUGEOT, RENAULT, SAAB, SEAT, VW, etc.

**Made in Germany**



### Impact Extractor 1969-16/2



- In conjunction with 4935-2/15 or 4935-42

**Made in Germany**

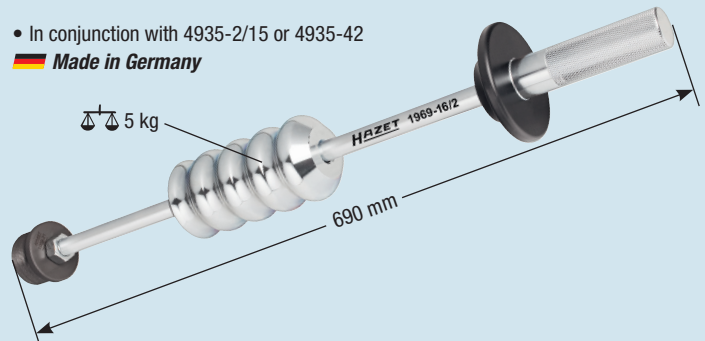

### Tool Set for Drive, Joint and Axle Shafts 900 SZ/4



**Made in Germany**



1 x $\varnothing$ 24 mm	VW Touran since 2006 and Passat C
1 x $\varnothing$ 30 mm	VW Golf 4, Polo and New Beetle, AUDI TT 1.8, SKODA Octavia, Superb, Fabia
1 x $\varnothing$ 32 mm	VW Touareg since 2003
1 x $\varnothing$ 36 mm	BMW 3-Series, 5-Series, 7-Series, Z3, M3, VW Polo since 2001, Golf Plus 1.8 TDI since 2005, SEAT Ibiza since 2002

### Clamping Screw Ejector for Four-Link Front Axle 2594-1/3



- For AUDI A4, A6 and VW Passat

**Made in Germany**



### Spreader for Wheel Bearing Housing 4912-1 /-2

**Made in Germany**



HAZET No.	Description
4912-1	Spreader for wheel bearing housing $\varnothing$ 5.5 x 8 mm for VW Fox since 2005, Polo since 2002, New Beetle, Golf years 1998–2004, Tiguan since 2008, Eos since 2006, Passat since 2006, Touran since 2003, Caddy since 2004, T5 since 2004, AUDI A2 since 2001, A3 since 2004, A4 years 2001–2008, A5 since 2008, A6 since 2008, TT since 2007, SEAT, SKODA
4912-2	Spreader for wheel bearing housing $\varnothing$ 5 x 7 mm for RENAULT, PEUGEOT, CITRÖEN

## Tool Set for Silent Blocks VW Golf 4 4925-2504/9



- Optional spindle set 4929-1/3
- For rubber / plastic and rubber /metal Silent Blocks
- Also suitable for **AUDI** A3, VW Bora, New Beetle, **SEAT** Leon, Toledo since 2001, **SKODA** Octavia since 1997
- In conjunction with 4932-17 (see page 50) also suitable for tight bearings

Made in Germany



## Tool Set for Silent Blocks VW Golf 5, Scirocco since 2009, AUDI TT/TTS 4925-2506/16



- Optional spindle set 4929-1/3
- For Silent Blocks at the rear axle of: **VW** Golf 5 Plus / Variant / 4Motion 2005–2012, Jetta / Syncro 2006–2012, Scirocco 2009–2012, Beetle 2012–, Eos 2006–2012, **SEAT** Altea 2004–2012, Leon 2006–2012, Toledo 2005–2009, **AUDI** A3 / S3 2004–2012, TT / TTS Coupe/ Roadster 2007–2012

Made in Germany



Made in Germany



Mechanical operation with spindle set 4929-1/3, page 54

**HAZET-CHANNEL**

Visit the  
Hazet-Channel



**HAZET-CHANNEL**

Video of how to use it

4925-2506/16



## Tool Set for Silent Blocks VW / AUDI / SEAT / SKODA 4925-2501/5



- For **VW** Polo 9N from 2002 to 2009, Fox since 2005, **AUDI** A2 since 2000 until 2005, **SEAT** Ibiza, Altea, Cordoba since 2003 until 2005, **SKODA** Fabia since 2000 until 2004

Made in Germany

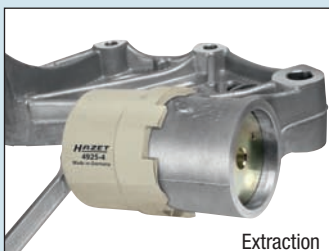
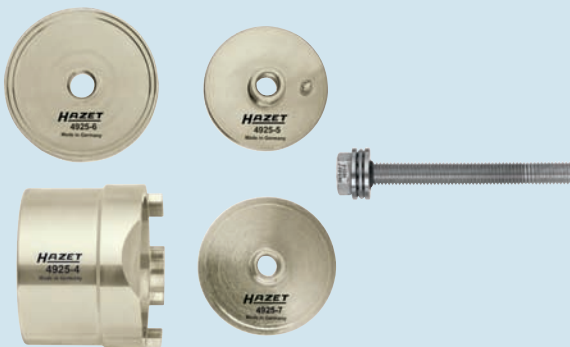

Extraction

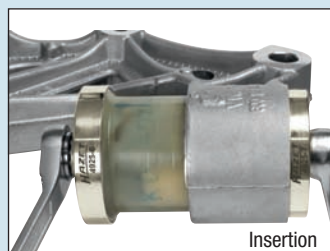

Insertion

## Tool Set for Silent Blocks VW T5 4925-2505/9



- For extracting and inserting Silent Block bushings **VW** T5 rear axle
- Mechanical drive with enclosed spindle
- In conjunction with 4925-2505/3 also suitable for 4932-17 (hydraulic)

Made in Germany

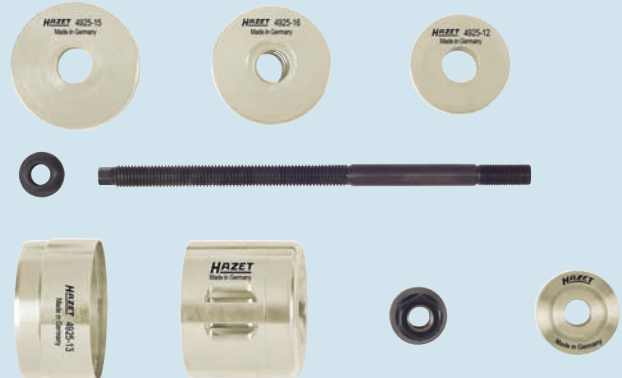



### Tool Set for Silent Blocks BMW 4929-2901/4



- Thrust pieces for extracting and inserting the **ball joint at the rear wheel carrier**
- For **BMW** types: 5-Series: E39 - E60 - E61 - E70, 6-Series: E63 - E64, 7-Series: E38 - E65 - E66 - E67, 8-Series: E52

**Made in Germany**

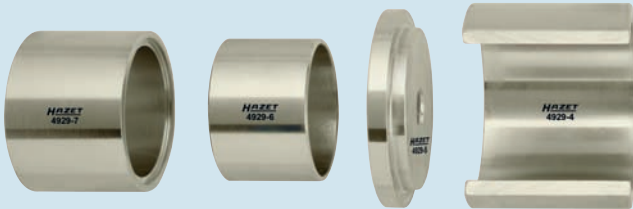

- 1 x 4929-4 Support sleeve
- 1 x 4929-5 Support washer
- 1 x 4929-6 Extraction pressure sleeve
- 1 x 4929-7 Pull-in pressure sleeve

### Tool Set for Silent Blocks BMW 4929-2902/3



- Device for extracting and inserting **ball joint and rubber mounting at the longitudinal control arm**
- **BMW** types: 3-Series: E36 - E46 - E83, 5-Series: E39 - E60 - E61 - E70, 6-Series: E63 - E64, 7-Series: E38 - E65 - E66 - E67, 8-Series: E31 - E52, Z4: E85 - E86

**Made in Germany**



- 1 x 4929-8 Extraction spacer sleeve
- 1 x 4929-9 Extraction sleeve
- 1 x 4929-11 Pull-in spacer sleeve

### Spindle Set 4929-1/3

- For operation of Silent Block Tool Sets 4929-2901/4, -2902/3, -2903/2 and -2904/4
- **Contents:** spindle, pressure nut with axial groove bearing, hexagon nut

**Made in Germany**



### Tool Set for Silent Blocks BMW 4929-2903/2



- For extracting and inserting the **rubber mounting at the rear axle carrier bottom, screw connection of the rear-axle transmission**
- **BMW** types: 3-Series: E36 - E46 - E83, 8-Series: E31, Z4: E85 - E86

**Made in Germany**



- 1 x 4929-12 Spacer sleeve
- 1 x 4929-13 Thrust piece [in conjunction with 4929-14 (sleeve) and 4929-18 (pressure disc)]

### Tool Set for Silent Blocks BMW 4929-2904/4



- For extracting and inserting the **rubber mounting at the front and rear gearbox mounting of the rear axle**
- **BMW** types: 1-Series: E81 - E87, 3-Series: E36 - E46 - E83 - E90 - E91 - E92 - E93, 5er Serie: E60 - E61, 6-Series: E63 - E64, 7-Series: E38 - E65 - E66 - E67, 8-Series: E31, Z4: E85 - E86, MINI type: Cooper S: R53

**Made in Germany**



- 1 x 4929-14 Sleeve
- 1 x 4929-15 Extraction thrust piece
- 1 x 4929-16 Pull-in thrust piece
- 1 x 4929-17 Pull-in pressure plate

### Tool Set for Silent Blocks FORD 4925-3401/4



- For operating the Silent Block at the rear axle of **FORD** Focus model year 2007, **VOLVO** C30, C70 Cabriolet, S40, V50
  - For use with press frame set 4926-2/3 and HAZET Hollow Piston Cylinder 4932-17 with Adapter 4932-M20
- Made in Germany**



1 x 4925-3401	Housing (Removal)
1 x 4925-3402	Pressure sleeve (removal)
1 x 4925-3403	Holding sleeves (installation)
1 x 4925-3404	Pressure sleeve (installation)

### Press Frame Set 4926-2/3



- For use with Silent Block Tool Set HAZET 4925-3401/4 and HAZET Hollow Piston Cylinder 4932-17
- Made in Germany**

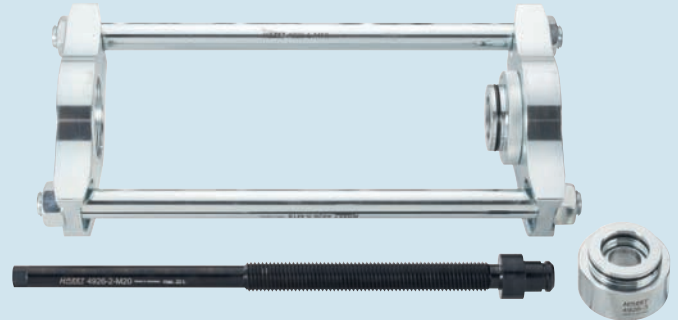

1 x 4926-1	Press frame with adapter 4926-7
1 x 4926-2-M20	Pressure spindle
1 x 4926-3	Adapter

### Tool Set for Silent Blocks FORD 4925-3401/7



- **Incl. press frame set**
  - For operating the Silent Block on the rear axle of **FORD** Focus, **Volvo** C30, C70 Cabriolet, S40, V50
  - For use with e.g. HAZET Hollow Piston Cylinder 4932-17 and Adapter 4932-M20
- Made in Germany**



1 x 4925-2401/4	Tool Set for Silent Blocks
1 x 4926-2/3	Press Frame Set

### Traction Device for Joint Bearings MERCEDES-BENZ 4927-2701/4



- For installation and removal of the joint bearing at the wheel bearing housing at the rear axle **without removing the wheel bearing housing**, amongst other for types 124, 201, 202, 203, 204, 208, 209, 210, 211, 212, 140
  - Spindle 4925-14 and spindle nut 4925-11 from Tool Set for Silent Blocks HAZET 4925-2505/9 (page 53)
- Made in Germany**

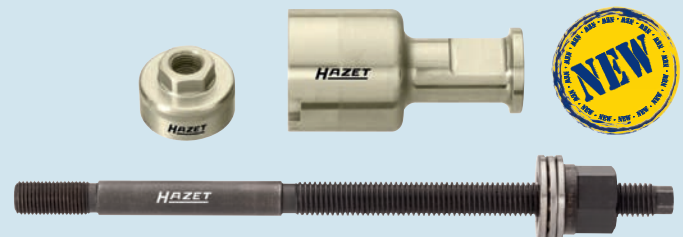
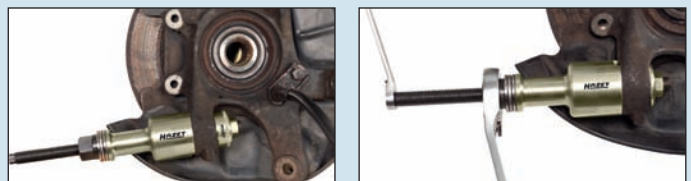

1 x 4925-14	Spindle TR 14 x 2
1 x 4925-11	Spindle nut TR 14 x 2
1 x 4927-2701	Housing (removal and installation)
1 x 4927-2702	Pressure sleeve (removal and installation)



### Inner Bearing Extractor Set 4931-1/8



- For  $\varnothing$  40-61 mm
  - Also for types with ABS housing (in particular for permanently attached versions)
  - Esp. suitable for inner bearing rings that rest against the wheel hub
  - For AUDI, BMW, FORD, MERCEDES-BENZ, PEUGEOT, RENAULT, TOYOTA, VW
- Made in Germany**



### Clamp Pliers 1847 and Pair of Clamping Jaws 1847-02/2



- CV boot clamp 1847 for installation of Hytrel axle boots and special stainless steel clamps
  - In conjunction with steering gear boots 1847-02/2 for AUDI A4 / A5 / A6 / A7 / Q5
- Made in Germany**



### SYSTEM-Release-Tool Assortment 4670-1/12



- Basic Set for approx. 80% of all motor car plug contacts
  - OEM quality
- Made in Germany**



Comprehensive range of system cable release tools, see also Illustrated List 2013 from page 263 on.

### Battery Starter 4651-24 / 4651N-12

- Large cable cross-section
- Integrated protective circuit
- Fuse (incl. 1 spare fuse): 500 A
- Acoustic signal in case of reversed polarity
- Surge protected
- 12 V electrical outlet / cigarette lighter
- Vehicle data (e.g. on-board computer) are retained when starter is connected during battery replacement



HAZET No.	Voltage V	Peak current load A	Continuous operation A	Cross-section of connecting lead mm <sup>2</sup>	Number of internal batteries	kg
4651-24	12/24	7400 (12 V operation)	2900	50	2	30
4651 N-12	12	3500 (12 V operation)	1150	30	1	12



Borescope / Inspection

Video Borescope  
4812-10/7

- Incl. software for live viewing at PC and/or laptop using Internet with e.g., Skype
- Instant replay of video or photos at TFT monitor
- Show and hide date and time easily
- Automatic power off to save energy
- Improved resolution

Incl. software for live viewing



Improved connection between probe and housing (metal), (adapter for using older probes optionally available)

All in one! Viewing, recording, replay on TFT display

Single-hand operation of the multifunction panel



Incl. additional features (control via probe):

- 1 Light boost for particularly dark environment
- 2 Image rotation on display in 90° steps
- 3 Anti-reflection and dust particle filter

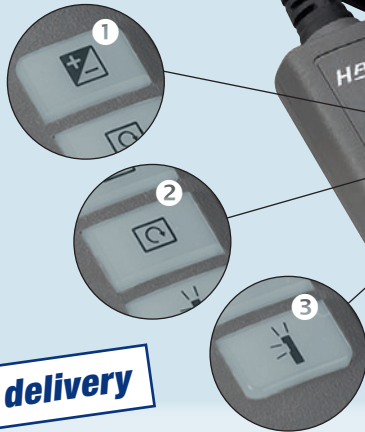

Premium Quality - Top Price!



Included in delivery

- Operating panel
- 1 m camera cable with 5.5 mm micro lens and LED light source with new additional features
- Mirror 110°



Incl. software for live viewing



4 AA batteries



USB cable (mini) AV (Cinch) cable



4 GB

Probes for 4812-10/7



4812-1 AF

HAZET No.	Designation	useable with 4812-10/7 with adapter
4812-1S	Ø 3.9 mm Sideview	X
4812-1F	Ø 3.9 mm Frontview	X
4812-1AF	Ø 6.0 mm Frontview 2 x 150°	X
4812-1AS	Ø 6.0 mm Sideview 2 x 150°	X
4812-5.5	Ø 5.5 mm Frontview	X
4812-20	Probe insert adapter with 4812-10/7	

# special worldwide 2013 Commercial Vehicles / Industry



Ingenious Tools

Valid until February 28, 2014



For Smartphones  
with QR-Reader (App)  
PDF Download of the  
SWW 2013

MECHANICAL ENGINEERING  
HEAVY INDUSTRY  
NEW ENERGY  
PLANT CONSTRUCTION



COMMERCIAL VEHICLES  
SHIPBUILDING  
RAILWAY ENGINEERING  
AERONAUTICS  
AGRICULTURAL ENGINEERING



# General Workshop Equipment

Work Bench / Tool Trolley with Assortment

## Work Bench 179 W-7/128

Made in Germany

128 expert tools!



## Assistant® 178-7/128

Made in Germany

128 expert tools!



or  
+

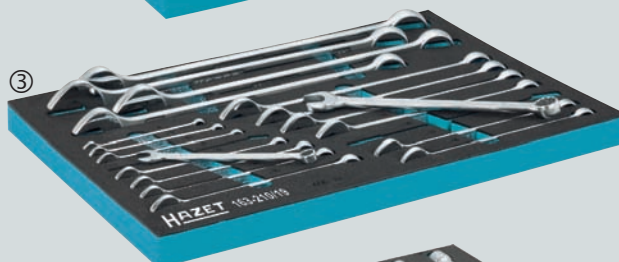
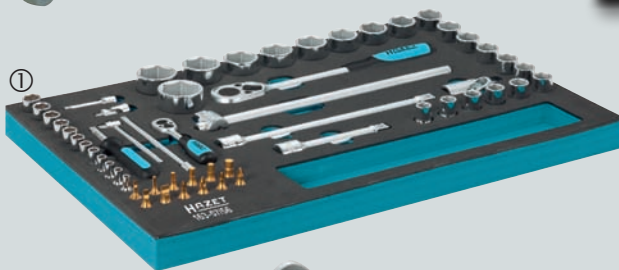

1 x Combination Wrench each s 36, 41 mm



1 x Double Open End Wrench each s 36x41, 46x50 mm



Magnetic Pick-Up Tool 1976



- ① **Socket Set 163-57/56, 56 pieces** (3/3)  
 s 4-14 mm s 10-34 mm
- ② **Tool Set 163-211/20, 20 pieces** (2/3)  
 s 8x9-34x36 mm T 60, T 80, T 100  
 s 14, 17, 19, 22 mm
- ③ **Combination Wrench Set 163-210/19, 19 pieces** (3/3)  
 s 8-34 mm
- ④ **Pliers Set 163-96/3, 3 pieces** (1/3)
- ⑤ **Screwdriver Sockets 163-119/23, 23 pieces** (2/3)  
 s 5-19 mm s 8-18 mm
- ⑥ **Soft Foam Insert with Compartments for Small Pieces 163-522 x 40 (x2)**



### Ratcheting Combination Wrenches 606-8 – 606-32

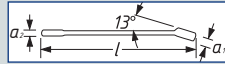

HAZET No.	S mm	a <sub>1</sub> mm	a <sub>2</sub> mm	l mm
606-8	8	6.8	4.9	129.9
606-9	9	7.2	5.2	143
606-10	10	7.6	5.6	154.5
606-11	11	8	6	168.6
606-12	12	8.5	6.4	180.3
606-13	13	8.9	6.7	193.2
606-14	14	9.3	7.1	204.6
606-15	15	9.7	7.4	218
606-16	16	10.2	7.7	230.2
606-17	17	10.6	8.1	242.2
606-18	18	11	8.5	255
606-19	19	11.5	9.1	268.3
606-21	21	13.3	12	291.5
606-22	22	13.3	12	291.5
606-24	24	14.8	12.5	333.1
606-27	27	15.8	14.7	359.2
606-30	30	17.3	15.2	402.5
606-32	32	17.8	15.7	425.8
606/5	8 – 19	–	–	–
606/5-S0	15 sets 606/5 in shopping-cart	–	–	–
606/6-1	21–32	–	–	–

### Telescopic Reversible Ratchet 916 Lg

12.5 1/2"

- Especially suitable for commercial vehicles, agricultural machinery and industrial installations
- max. 600 Nm

Made in Germany



### Reversible Ratchet 916 L

12.5 1/2"

- Especially suitable for commercial vehicles, agricultural machinery and industrial installations
  - Long, strong version
  - Hardened and tempered special steel
- Made in Germany



### Socket Set 1000

20 3/4"

Made in Germany



578 x 235 x 88 mm

10 x		s 22 24 27 30 32 36 38 41 46 50 mm
2 x		l 200 400 mm
1 x		
1 x		
1 x		



## Hand Tools

Pliers / Thread Cutters / Torque Tools

### Circlip Pliers

1846 a-5 / 1846 c-5

- For the application on commercial vehicles, building and agricultural machinery

 **Made in Germany**

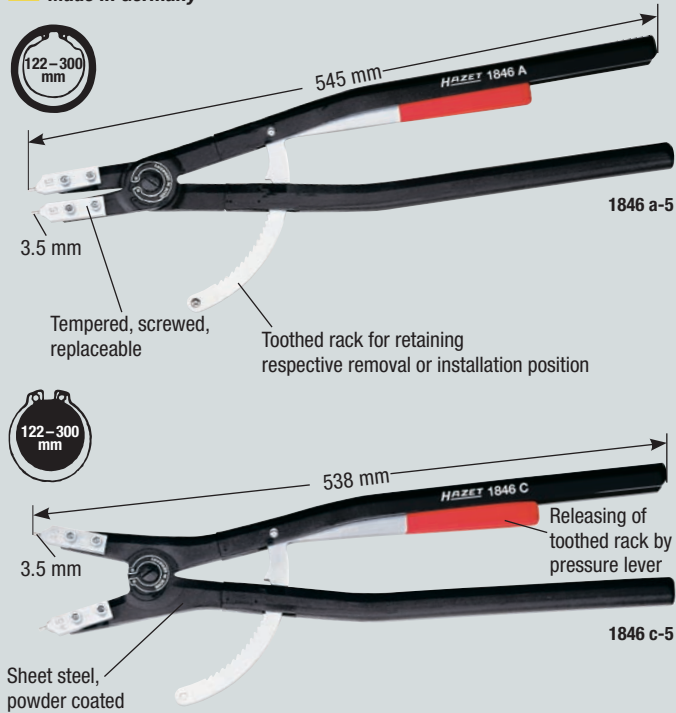

### Universal Thread Repair Tool

842 AG-3 / 842 AG-4

- Repairs right- and left-hand threads



HAZET No.	 M
842 AG-3	16 – 38 mm ( $\frac{5}{8}$ " – $1\frac{1}{2}$ " )
842 AG-4	35 – 152 mm ( $1\frac{3}{8}$ " – 6" )



## Torque Technology

### Torque Wrenches SYSTEM 6000 CT 300 – 2000 Nm





6145-1 CT – 6170-1 CT

- Release accuracy (tolerance) of scale value (in operating direction) according to DIN EN ISO 6789:2003 (D)
- Especially suited for industrial climbers
- In carrying case with handle and shoulder strap (6145-1 CT in Safe-Box)
- Separable by release tool (except 6145-1 CT)

 **Made in Germany**



With serial number and certificate

HAZET No.	Drive	Torque range Nm	l mm	Tolerance ±%	Graduation Nm	Release force	 kg
6145-1 CT	 20 $\frac{3}{4}$ "	300 – 800	1280	2	2.5	Only 685 N (70 kg) at 800 Nm	8.3
6150-1 CT	 20 $\frac{3}{4}$ "	400 – 1000	1788	3	5	Only 590 N (60 kg) at 1000 Nm	10
6160-1 CT	 25 1"	600 – 1600	2455	3	5	Only 685 N (70 kg) at 1600 Nm	14
6170-1 CT	 25 1"	800 – 2000	3034	4	6	Only 685 N (70 kg) at 2000 Nm	18



Impact Wrench 20 3/4"   
9013 MG

NEW GENERATION NEW DESIGN NEW GENERATION NEW DESIGN NEW GENERATION



HAZET No.	■	↻ max. Nm	↻ Air consumption l/min	Working pressure bar	👂 dB(A)	⚖ kg
9013 MG	20 3/4"	1627	198	6.3	Lp A 96.8	5.1

Impact Wrench 25 1"   
9014 MG / 9014 MG-Lg



HAZET No.	■	↻ max. Nm	↻ Air consumption l/min	Working pressure bar	👂 dB(A)	⚖ kg
9014 MG	25 1"	2303	269	6.3	Lp A 111.2	8.5
9014 MG-Lg	25 1"	2303	269	6.3	Lp A 111.2	10.9

Air Ratchet 9022 Lg-1

125 1/2"



HAZET No.	↻ 1/min	↻ max. Nm	🔌 Coupler plug nominal size	↻ Air consumption l/min	Working pressure bar	👂 dB(A)	l mm	⚖ kg
9022 Lg-1	150	122	6.3 mm = 1/4"	142	6.3	Lp A 90	365	2.0



Workshop Tools

Lever / Pry Bar 652 / 2166-4

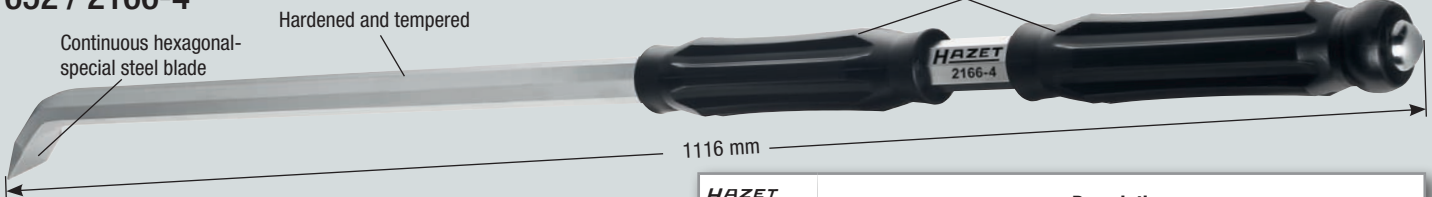

HAZET No.	Description
652	Tyre levers   Made in Germany
2166-4	Double-Handled Pry Bar for commercial vehicles



## Engine

### TORX® Cylinder Head Tool 20 3/4"

#### 2850-E 18 /-E 20 /-E24

 Made in Germany



HAZET No.	Description
2850-E 18	For MAN M 2000 and MAN buses with D 08 engines
2850-E 20	For MAN F 2000, F 90, F 8 and MAN buses with D 25 and D 28 engines
2850-E 24	For MAN with Common Rail Engine D20

### Turbocharger Wrench 2849-15

- Loosen and tighten turbocharger nuts on MAN commercial vehicles
-  Made in Germany

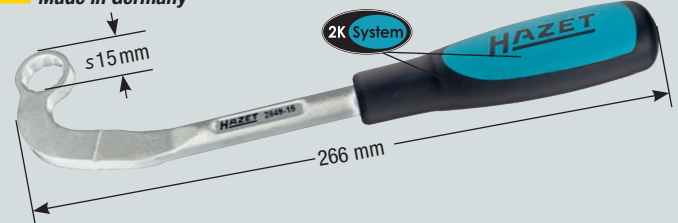

## Oil Service

### Cartridge Wrench 12 1/2"

#### 2195

- For commercial vehicles with compressed air dryer e.g. MERCEDES-BENZ, MAN
  - Negative position of arms
  - Special steel, forged design
  - MAN-No. 8099606-0307
-  Made in Germany



### Ad-Blue®-Filter Wrench 10 3/8"

#### 2168-46

- For MERCEDES-BENZ commercial vehicles with Blue Tec® engines, e.g. Actros, Atego, Axor, Econic
  - Vehicle manufacturer's recommended tightening torque (follow manufacturer's specifications) is achieved with e.g. torque wrench HAZET 6110-1 CT
-  Made in Germany



## Chassis

### Wheel Hub Grinder for Commercial Vehicles

#### 4961-23/11

- Prevents misinterpretation of wheel bolt tightening torque due to corrosion
- Minimal dust formation due to open-pore abrasive and cup-shaped grinding disc
- No formation of sparks
- Maximum inner-Ø: 23 mm
- Grinding wheels-Ø: 56 mm

**Contents:** 1 grinding pad with 1 grinding wheel  
5 grinding wheels for moderate soiling  
5 grinding wheels for heavy soiling



HAZET No.	Spare Grinding Wheels	
4961-023M/5	For moderate stains	5
4961-023S/5	For heavy stains	5

### Four-Way Rim Wrench 20 3/4"

#### 720 S

- Tested up to 2000 Nm
  - DIN 3119
  - 24 x 27 x 32 x 20 3/4"
-  Made in Germany

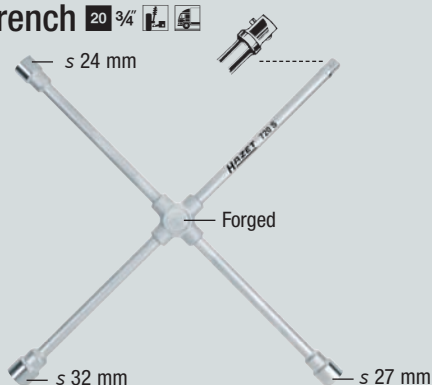



### XZN Impact Screwdriver Socket 12 1/2"

#### 990 S/11

- Especially for commercial vehicles (also for passenger cars)
  - Drive: either 12 1/2" or 24 mm
-  Made in Germany



3 x		/ 43 mm	s 14	16	18 mm
3 x		/ 75 mm	s 14	16	18 mm
1 x		20 3/4" - Ø 24 mm			

Includes each two o-rings and connecting pins

## Universal Axle and Slotted Nut Wrench 20 3/4 772-2/16

- Clamping range 35–170 mm
- Max. torque 700 Nm

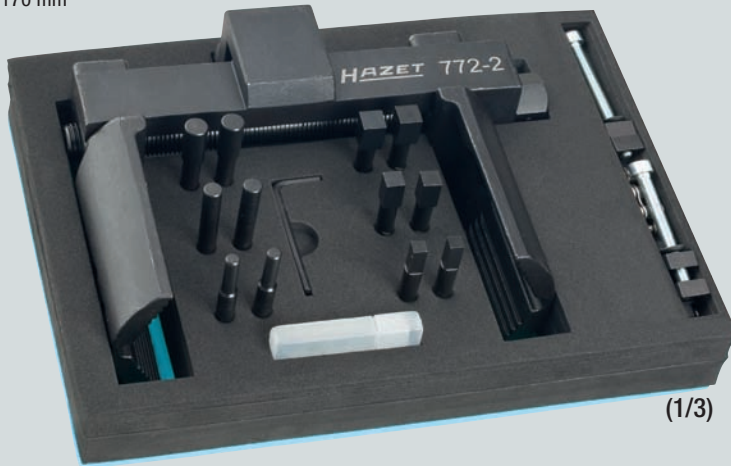

(1/3)

Assistant



## Universal Pressure Sleeve Set 4926-1/36

- E.g. for vans, off-road and commercial vehicles
- Pressure sleeves from 74–112 mm Ø

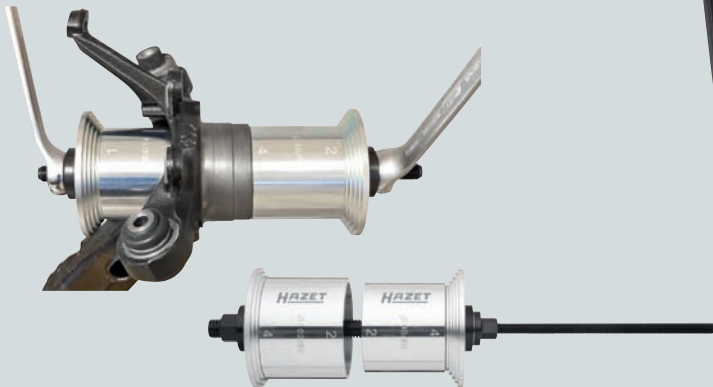

## Brakes

### Brake Calliper TORX® Socket 2871-E 18 – 2871-E 24

- Use with HAZET Insert Box Wrench 6630 d-22 together with tool holder 6397 (loosen), torque wrench 6293-1 CT or 6295-1 CT (tighten)
- Made in Germany



HAZET No.		Description
2871-E 18	E 18	E.g. for MAN TGM and TGL
2871-E 20	E 20	E.g. for MAN TGM and TGA
2871-E 24	E 24	E.g. for MAN TGA, TGS and TGX

### TORX® Screwdriver Sockets 1012-T 60 – 1012-T 100

- E.g. for track rod arm on MAN commercial vehicles
- 1012-T 80 for MAN series M, 1012-T 100 for MAN series F
- Made in Germany



HAZET No.		mm
1012-T 60		13.25
1012-T 70		15.54
1012-T 80		17.59

HAZET No.		mm
1012-T 90		19.95
1012-T 100		22.15