

## Belt drive

**Function:**

This unit consists of a rectangular aluminium profile with 2 integrated roller guides. The carriage is moved by a belt drive. Each standard pulley has got one coupling claw on one side. Belt tension can be readjusted by a simple screw adjustment device in the carriage. This device can also be used for symmetrical adjustment of two or more linear units running parallel. The openings of the guide body are sealed with 3 stainless steel cover bands to protect the guide from splash water and dust. Alternatively, the opening can also be covered with a bellow or can be delivered without cover bands.

**Fitting position:**

As required. Max. length 6.000 mm without joints.

**Carriage mounting:**

By T-slots.

**Unit mounting:**

By T-slots and mounting sets. The linear axis can be combined with any T-slot profile.

**Belt type:**

HTD with steel reinforcement, no backlash when changing direction, repeatability  $\pm 0,1$  mm.

**Carriage support:**

In the standard version, the carriage runs on 8 rollers which can be adjusted and serviced at a central servicing position. For longer carriages the number of rollers can be increased.

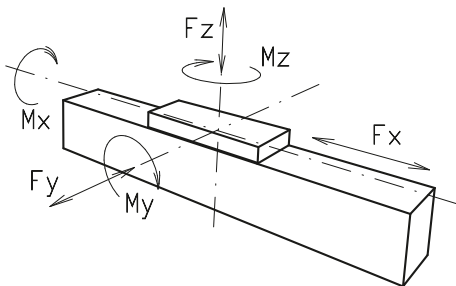
**Forces and torques**

| Size   | 120  |         | 160                 |         | 200                |         |
|--|--|---------|---------------------|---------|--------------------|---------|
|  | static   | dynamic | static              | dynamic | static             | dynamic |
| <b>Forces/Torques</b>                                      |  |         |                     |         |                    |         |
| $F_x$ (N)  | 894  | 800     | 1900                | 1800    | 4000               | 3800    |
| $F_y$ (N)  | 1100   | 900     | 3000                | 2000    | 4400               | 3100    |
| $F_z$ (N)  | 1250   | 1000    | 3500                | 2800    | 4900               | 4400    |
| $M_x$ (Nm)   | 150  | 125     | 400                 | 320     | 600                | 510     |
| $M_y$ (Nm)   | 140  | 120     | 360                 | 300     | 560                | 480     |
| $M_z$ (Nm)   | 100  | 90      | 180                 | 150     | 310                | 275     |
| <b>All forces and torques related to the following:</b>    |  |         |                     |         |                    |         |
| existing values  | $\frac{F_y}{F_{y_{dyn}}} + \frac{F_z}{F_{z_{dyn}}} + \frac{M_x}{M_{x_{dyn}}} + \frac{M_y}{M_{y_{dyn}}} + \frac{M_z}{M_{z_{dyn}}} \leq 1$ |         |                     |         |                    |         |
| table values   |  |         |                     |         |                    |         |
| <b>No-load torque</b>                                      |  |         |                     |         |                    |         |
| Nm without cover bands                                     | 1,2  |         | 1,5                 |         | 1,8                |         |
| Nm with cover bands  | 1,6  |         | 2,1                 |         | 4                  |         |
| <b>Speed</b>   |  |         |                     |         |                    |         |
| (m/s) max  | 4  |         | 6                   |         | 8                  |         |
| <b>Tensile force</b>                                       |  |         |                     |         |                    |         |
| permanent (N)  | 900  |         | 1900                |         | 4000               |         |
| 0,2 s (N)  | 1000   |         | 2090                |         | 4300               |         |
| <b>Geometrical moments of inertia of aluminium profile</b> |  |         |                     |         |                    |         |
| $I_x$ mm <sup>4</sup>                                      | $6,6 \times 10^5$  |         | $22,2 \times 10^5$  |         | $63,8 \times 10^5$ |         |
| $I_y$ mm <sup>4</sup>                                      | $38,6 \times 10^5$   |         | $122,0 \times 10^5$ |         | $335 \times 10^5$  |         |
| Elastic modulus N/mm <sup>2</sup>                          | 70000  |         | 70000               |         | 70000              |         |

For life-time calculation of rollers use our homepage.

Driving torque:

$$M_o = \frac{F \cdot P \cdot S_i}{2000 \cdot \pi} + M_n$$

$$P_o = \frac{M_o \cdot n}{9550}$$

$F$  = force (N)  
 $P$  = pulley action perimeter (mm)  
 $S_i$  = safety factor 1,2 ... 2  
 $M_n$  = no-load torque (Nm)  
 $n$  = rpm pulley (min<sup>-1</sup>)  
 $M_o$  = driving torque (Nm)  
 $P_o$  = motor power (KW)

Deflection:

$$f = \frac{F \cdot L^3}{E \cdot I \cdot 192}$$

$f$  = deflection (mm)  
 $F$  = load (N)  
 $L$  = free length (mm)  
 $E$  = elastic modulus 70000 (N/mm<sup>2</sup>)  
 $I$  = second moment of area (mm<sup>4</sup>)

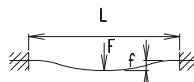

# Positioning system DLZ 120, 160, 200

Dimensions (mm)

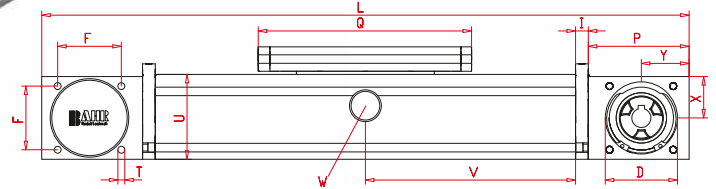
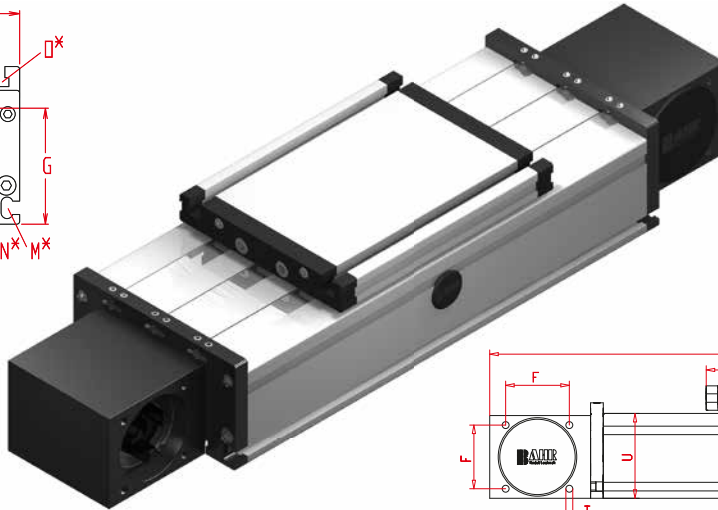
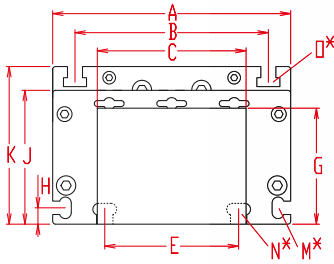

V = Q + 100 mm  
W = servicing position

\*For slide nuts refer to chapter 2.2 page 2

Increasing the carriage length will increase the basic length by the same amount.

| Size    | Basic length L | A   | B   | C   | D<br>-0,05 | E   | F  | G  | H  | I  | J   | K   | M for | N for | O for | P   | Q   | T   | U   | X  | Y  | Basic weight | Weight per 100 mm |
|---------|----------------|-----|-----|-----|------------|-----|----|----|----|----|-----|-----|-------|-------|-------|-----|-----|-----|-----|----|----|--------------|-------------------|
| DLZ 120 | 330            | 120 | 96  | 80  | 47         | 78  | 42 | 58 | 10 | 10 | 68  | 79  | M 5   | M 6   | M 6   | 70  | 156 | M 6 | 60  | 28 | 35 | 5,1 Kg       | 0,85 Kg           |
| DLZ 160 | 440            | 160 | 130 | 100 | 68         | 90  | 60 | 78 | 11 | 12 | 90  | 106 | M 6   | M 8   | M 8   | 95  | 200 | M 8 | 80  | 39 | 45 | 13,0 kg      | 1,69 kg           |
| DLZ 200 | 530            | 200 | 160 | 130 | 90         | 140 | 80 | 97 | 15 | 15 | 110 | 129 | M 8   | M10   | M10   | 110 | 270 | M10 | 100 | 49 | 50 | 23,4 kg      | 2,33 kg           |

7.1

**0 Choice of guide body profile:**

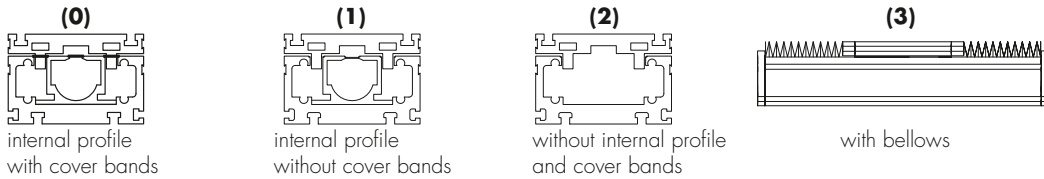

Stainless versions upon request.

**0 Choice of carriage:**

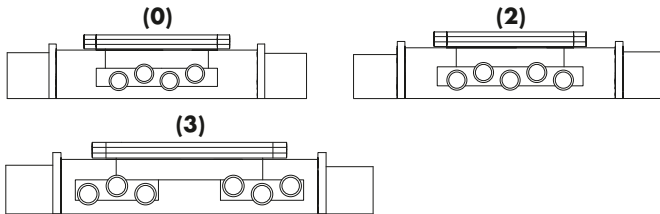

| Size | Version 0 |     | Version 2 |     | Version 3 |      |
|------|-----------|-----|-----------|-----|-----------|------|
|      | Q         | L   | Q         | L   | Q         | L    |
| 120  | 156       | 330 | 196       | 370 | >236      | >410 |
| 160  | 200       | 440 | 250       | 490 | >300      | >540 |
| 200  | 270       | 530 | 330       | 600 | >410      | >680 |

**0 Drive version:**

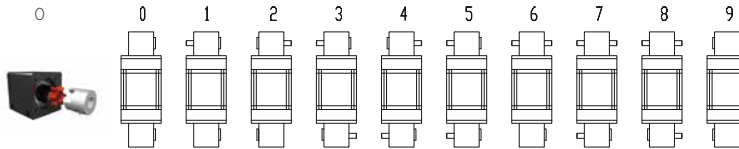

9 is as 0, but with coupling claws on both sides.  
The standard version is supplied without shaft. A shaft can be retrofitted by inserting it into the pulley bore and securing it with 2 locking rings or tension sets (size 200).

**Belt table**

| Code No. | Size | Belt | mm/rev. | Number of teeth |
|----------|------|------|---------|-----------------|
| 0 4      | 120  | 5M25 | 130     | 26              |
| 0 7      | 160  | 8M30 | 176     | 22              |
| 0 9      | 160  | 8M50 | 176     | 22              |
| 0 9      | 200  | 8M50 | 224     | 28              |
| 1 0      | 200  | 8M70 | 224     | 28              |

**Shaft dimensions / Coupling claw**

| Size       | Shaft<br>ø h6 x length | Key    | Coupling |
|------------|------------------------|--------|----------|
| 120 (5M25) | 14 x 35                | 5x5x28 | 14       |
| 160 (8M30) | 18 x 45                | 6x6x40 | 19       |
| 160 (8M50) | 25 x 35                | 8x7x32 | — *      |
| 200 (8M50) | 22 x 45                | 6x6x40 | 24       |
| 200 (8M70) | 30 x 55                | 8x7x50 | — *      |

DLZ 160 1 0 0 0 0 7 1 01500 — Basic length + stroke = total length

\* Coupling claw not possible with belt widening.

Pos. 1 2 3 4 5 6 7

Sample ordering code:

DLZ160 with internal profile and cover bands, standard carriage, coupling claw on one side, 1060 mm stroke.

