

CA-61K, CA-62K, CA-62KB MANUAL

Date: 2015/12/25
Doc.: T10-00103(V1.0)

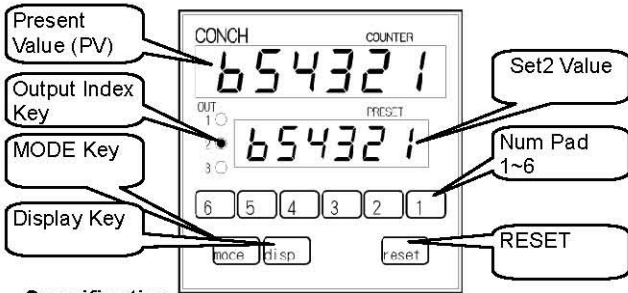

Key Name	Function
Mode	To enter setting mode during counting, and switch among parameters.
Display key	Finish setting and return to counting mode.
Increment key(1- 6)	To change parameter values.
Reset key	PV resets and Outputs return.

■ Specification

Power Supply	AC 100V to 240V 60/50Hz ±10%	
Power Consumption	8VA MAX.	
Max. Counting Speed	25 Hz, 300Hz, 3kHz (selectable)	
Inputs	Non-voltage inputs	ON impedance 2kΩ max. ON residual voltage 3V max. OFF impedance 900kΩ min.
	Voltage inputs	High level 6 to 25 VDC Low level 2 to -12VDC Input resistant Approx. 8.2kΩ
	Controls Output	Contact: 5A, 240VAC, resistive load (p.f=1).
DC Output for Sensor	+12v, 100mA MAX.	
Ambient Operating Temp.	-10 to 55°C with no icing	
Storage Temperature	-25 to 65°C with no icing	
Ambient Operating Humidity	35% to 85% RH	

■ Wiring Diagram

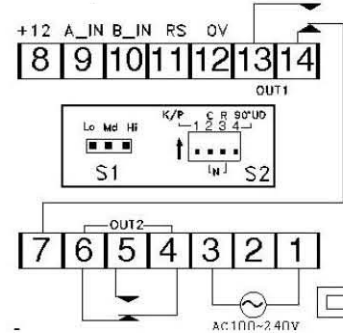

■ Set the Value of SET2 Directly During Counting

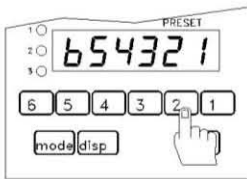

SET2:

PV ≥ SET2, OUT2 on.
The output time and mode are settable. Press 1 ~ 6 directly during counting.

■ Output Mode:

N Mode:

PV = SV, OUT1 & OUT2 turn on and hold until RESET manually.

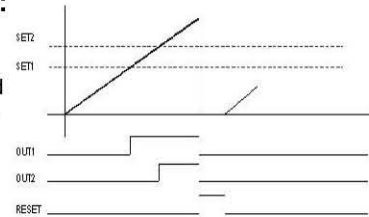

■ Setting of Other Parameters (Press "MODE" to start)

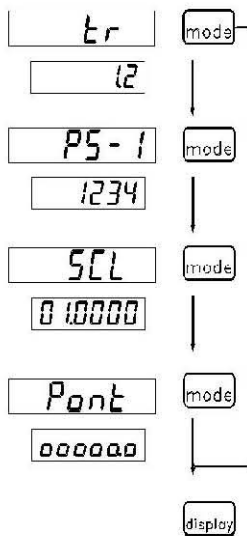

Output Time (tr):

Hold time setting of OUT2 & OUT1.
Range: 0.1 ~ 9.9sec. Press Key 1 & 2 to set.

SET1 (PS-1):

PV ≥ SET1, OUT1 On and hold. (For CA-62KB, PV ≥ SET2-SET1)
Press Key 1 ~ 6 to change.

Scaling (SCL):

The parameter can convert input signal into actual physical quantity (volume, length, etc.). For example, if input signal is 0.1mm per pulse, then the scale should be set as 0.1.
Range: 0.0001 ~ 99.9999. Press 1 ~ 6 to change the value.

Decimal Place (Pont):

To change the decimal place of PV.
Press 1 ~ 5 to change its position.

R Mode:

PV = SV, OUT1 & OUT2 turn on and hold for "tr" time, and then reset with PV.

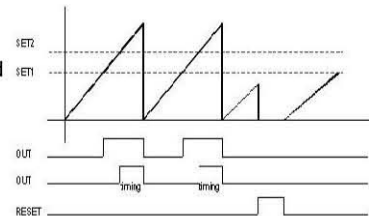

C Mode:

PV = SV, PV resets at once, OUT1 & OUT2 turn on and hold for "tr" time, and then reset automatically.

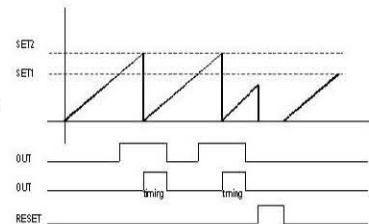

■ Key Protection (K/P)

When S2-1 is at ON position, settings of "SCL", "Pont" and "PS-1" are disabled.

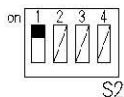

■ Input Speed (Set with Switch S1)

Hi: 3kHz
Mi: 300Hz
Lo: 25Hz

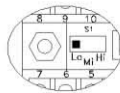

■ Counting Mode

S2-4 is at OFF, A_IN: up counting, B_IN: Gate
S2-4 is at ON, Up/Down count with 90° quadrature signal input from A_IN, B_IN.

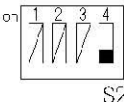

(Reboot is necessary.)

■ Dimension & Panel Cut-out:

