

AV 23 SETTER Bypass SD

Balancing valves

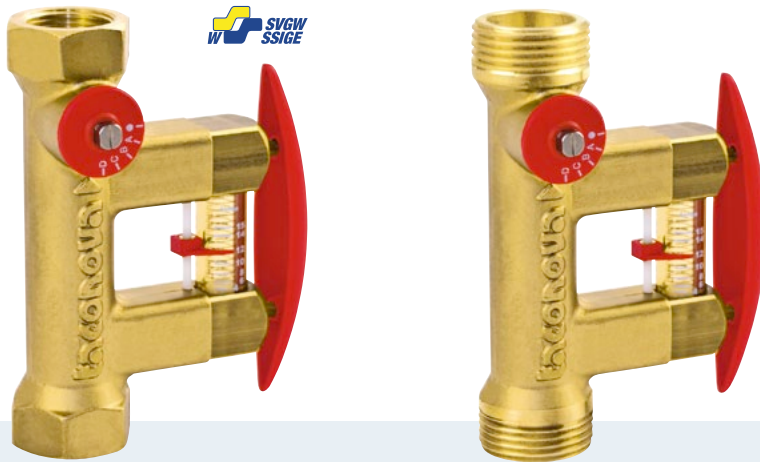

Direct regulation, indication and isolation of flows in systems

Description

Direct hydraulic balancing and control of flows to consumers or in a subsystem. SETTER Bypass balancing valves offer an easy and accurate method of adjusting the flow rates for heating-, ventilation-, air conditioning- and cooling systems.

Correct balancing of hydraulic circuits ensures optimum energy distribution, resulting in more efficient and economical operation in accordance with the energy saving regulations provided for by legislation.

With SETTER Bypass SD balancing valves, any qualified fitter can set the appropriate flow rate using the unique flow measurement device, avoiding investments in training and costly measuring devices.

Installation

The SETTER Bypass SD requires a straight section of pipe of the same length and diameter as the system. The valve can be installed in a horizontal, vertical or inclined position. Care should be taken that the arrow is pointing in the direction of the flow.

Advantages

- Accurate and fast balancing without diagrams, tables or measuring devices
- Direct reading of adjusted flow rate in l/min
- High accuracy of measurement in the optimal flow range
- Flow control by means of set point slide
- Balancing valve with adjustment scale
- Balancing valve with isolating facility
- Installation in any position
- Maintenance free
- Low pressure loss
- Replace measuring cylinder unit at full system pressure
- Saving of an additional shutoff device

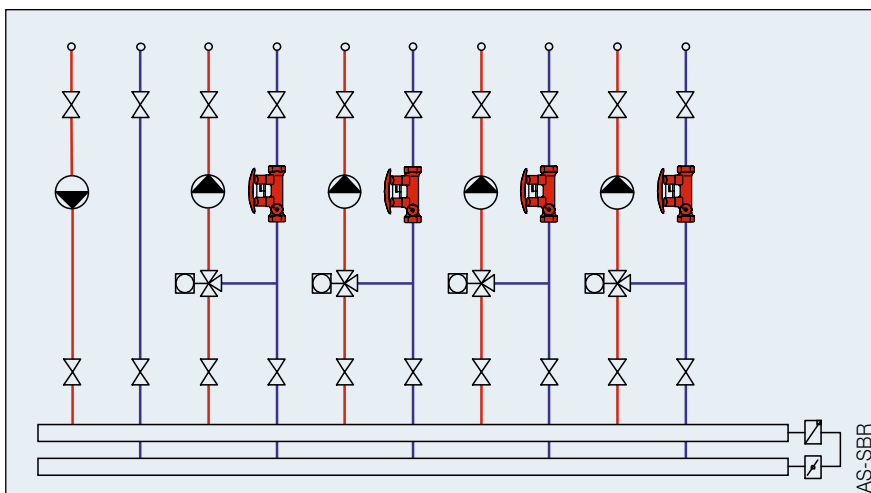

Operation

The flow measurement is based on the principle of a baffle float with return spring. The reading position is the bottom line of the baffle float.

The measuring device is placed in a bypass to the main flow, isolated from system flow. By demand the bypass, with self locking valves, gets opened / closed by pressing / releasing the clamp. Reading the flow rate has no influence on the main flow rate.

AV 23 SETTER Bypass SD



Specification text

Regulating and stop valve with direct indication of the set flow rate in l/min.

Automatic isolating bypass with gauge and indicator running parallel to the main flow rate.

Gauge with baffle float and return spring. Measured values can be set and read directly at the sight glass without tables, diagrams or measuring devices.

Low pressure loss.

Technical data

Max. operating temperature: TB 100 °C

Max. operating pressure: PB 10 bar

Measuring accuracy:

- Measurement range 20 to 80%
= ±5% of the indicated value
- Measurement range up to 20%
and over 80%
= ±10% of the indicated value

k_{VS} value and measurement range see "Type program".

Material:

Housing: brass

Inside: stainless steel, brass, plastic

Sight glass: heat- and impact resistant plastic

Seals: EPDM

Female thread to DIN 2999/ISO 7 or male thread G (cylindrical) to ISO 228

Fluids

- Heating water (VDI 2035)
- Cooling water
- Potable water (with SVGW-certificate)
- Water and proprietary additives used against corrosion and freezing (see document "Correction curves")

Additional models

Setter for solar applications, see data sheets Setter Bypass SD Solar and Setter Bypass HT Solar.

Type program

Female thread

Code No.	DN	Rp x Rp	Measuring range	k_{VS} (m ³ /h)
223.2262.000	15	½" x ½"	2 – 8 (l/min)	1,95
223.2360.000	20	¾" x ¾"	4 – 15 (l/min)	3,3
223.2362.000	20	¾" x ¾"	8 – 30 (l/min)	5,0
223.2460.000	25	1" x 1"	6 – 20 (l/min)	5,1
223.2461.000	25	1" x 1"	10 – 40 (l/min)	8,1
223.2561.000	32	1 ¼" x 1 ¼"	20 – 70 (l/min)	17,0
223.2661.000	40	1 ½" x 1 ½"	30 – 120 (l/min)	30,0
223.2861.000	50	2" x 2"	50 – 200 (l/min)	54,0

Male thread

Code No.	DN	G x G	Measuring range	k_{VS} (m ³ /h)
223.2272.000	20	1" x 1"	2 – 8 (l/min)	2,2
223.2370.000	20	1" x 1"	4 – 15 (l/min)	3,3
223.2372.000	20	1" x 1"	8 – 30 (l/min)	5,0
223.2470.000	25	1 ¼" x 1 ¼"	6 – 20 (l/min)	5,1
223.2471.000	25	1 ¼" x 1 ¼"	10 – 40 (l/min)	8,1
223.2571.000	32	1 ½" x 1 ½"	20 – 70 (l/min)	17,0

Dimensions

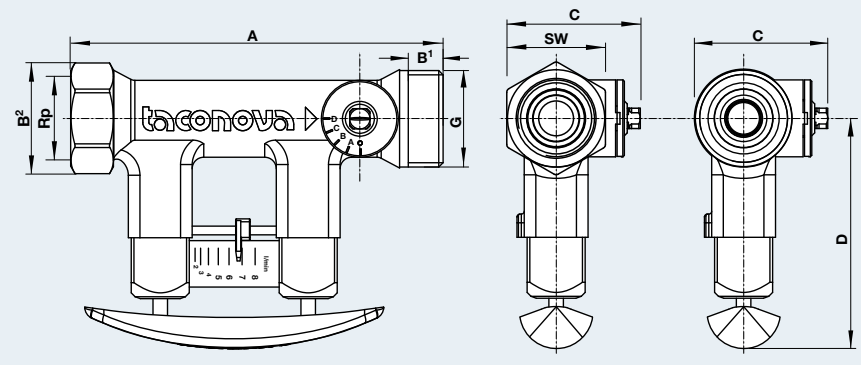

Dimensions table

Female thread

Code No.	DN	A	B ¹	C	D	SW	Rp
223.2262.000	15	142	39	46	79	34	½"
223.2360.000	20	129	39	46	79	34	¾"
223.2362.000	20	129	39	46	79	34	¾"
223.2460.000	25	152	47	58	82	41	1"
223.2461.000	25	152	47	58	82	41	1"
223.2561.000	32	161	56	65	84	49	1 ¼"
223.2661.000	40	173	64	79	90	59	1 ½"
223.2861.000	50	197	76	91	97	70	2"

Male thread

Code No.	DN	A	B ²	C	D	G
223.2272.000	20	129	12	46	79	1"
223.2370.000	20	129	12	46	79	1"
223.2372.000	20	129	12	46	79	1"
223.2470.000	25	152	15	58	82	1 ¼"
223.2471.000	25	152	15	58	82	1 ¼"
223.2571.000	32	161	15	65	84	1 ½"

AV 23 SETTER Bypass SD



Pressure loss diagrams

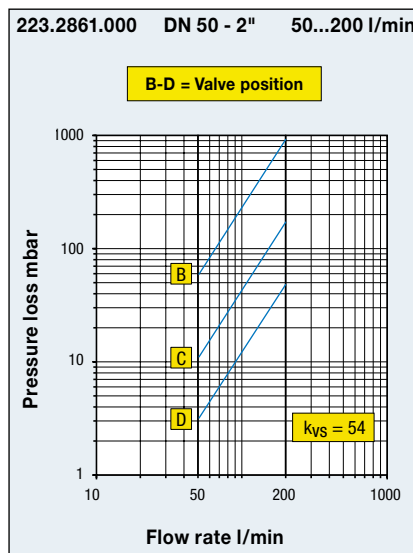
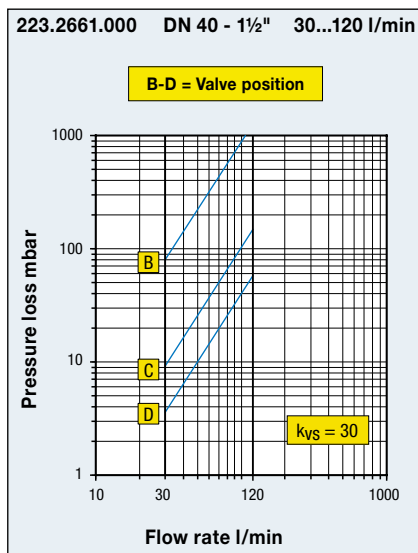
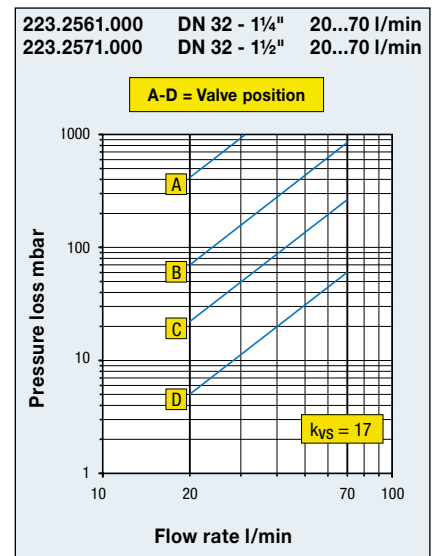
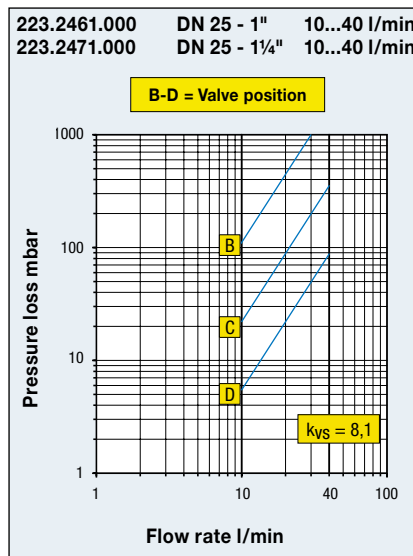
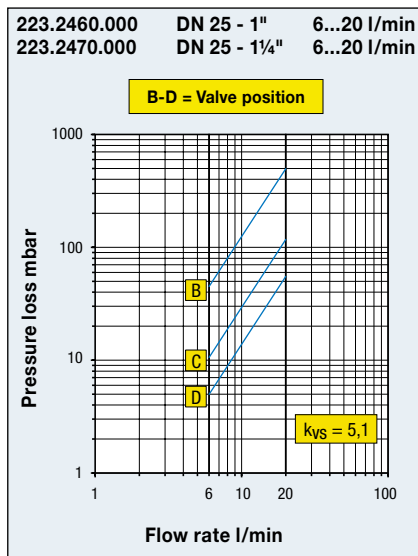
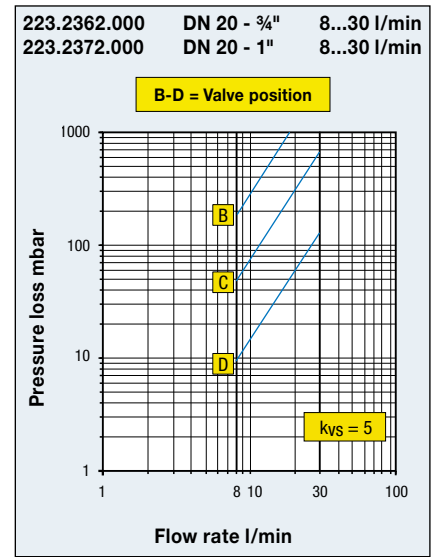
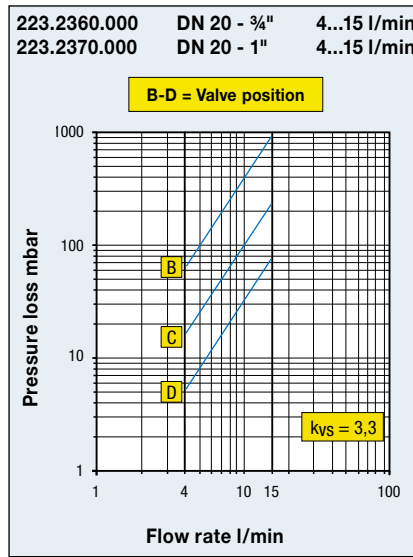
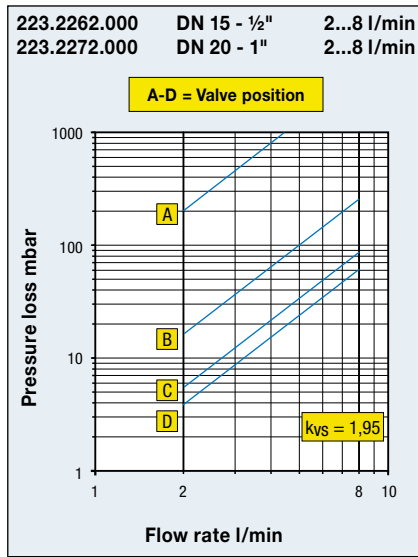

AV 23 SETTER Bypass SD

Accessories



AX 96 Isolation box

Made of EPP, operating temp. -30 – 130 °C, in accordance with EnEV guideline

Code no.	Fits to Setter Bypass SD
296.2321.004	DN 15 + DN 20
296.2322.004	DN 25
296.2323.004	DN 32
296.2324.004	DN 40
296.2325.004	DN 50



VF 10 system screw connection fits to Setter with male thread

Screw connection with male thread R (conical) as per DIN 2999, set of 3 parts

Code no.	G x R	Version for	Fits to
210.6632.000	1" x 3/4"	threaded pipe 3/4"	DN 20
210.6633.000	1 1/4" x 1"	threaded pipe 1"	DN 25

Screw connection with solder connection, set includes 2 x 3 parts

Code no.	G x mm	Version for	Fits to
210.5331.019*	1" x 18	copper pipe 3/4"	DN 15
210.5332.019*	1" x 22	copper pipe 3/4"	DN 20
210.5334.003	1 1/4" x 28	copper pipe 1"	DN 25

* with solar seal

Spare parts

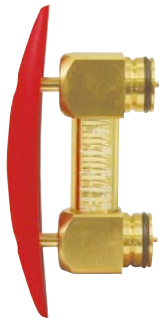

AY 98 Bypass SD spare part kit

Code no.	Measuring range	Fits to	P/u
298.2333.020	2 – 8 (l/min)	223.2262/2272.000	1
298.2334.020	4 – 15 (l/min)	223.2360/2370.000	1
298.2335.020	8 – 30 (l/min)	223.2362/2372.000	1
298.2342.020	6 – 20 (l/min)	223.2460/2470.000	1
298.2343.020	10 – 40 (l/min)	223.2461/2471.000	1
298.2352.020	20 – 70 (l/min)	223.2561/2571.000	1
298.2362.020	30 – 120 (l/min)	223.2661.000	1
298.2382.020	50 – 200 (l/min)	223.2861.000	1